

tbloc

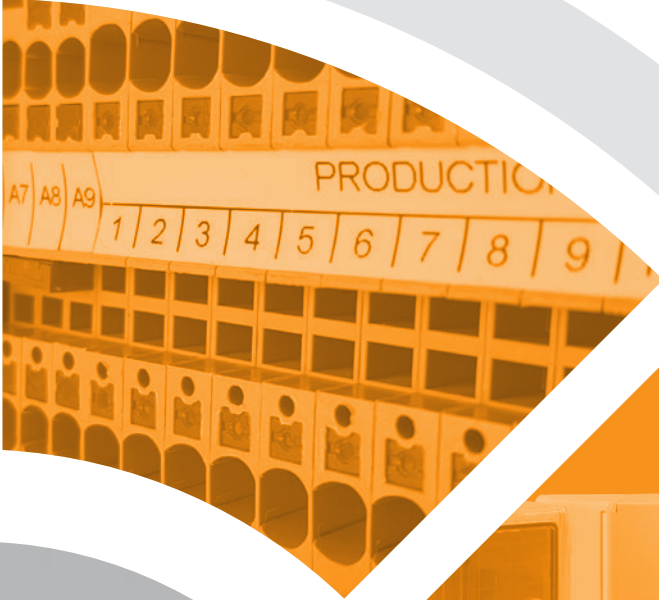

Ürün Kataloğu
Product Catalog

İçindekiler

Index

Vida Bağlantılı Ray Klemensleri	Screw Type Terminal Blocks	06 - 25
Push-in Klemensleri	Push-in Terminal Blocks	26 - 31
Sıra Klemensleri	Terminal Strips	32
Durdurucular	End Bracket	32
Grup Etiketi	Group Marker	33
Etiket Şemsiyesi	Marker Holder	33
Nihayet Plakaları	End Plates	34
Ayrırma Plakaları	Partition Plates	35
Test Fişleri	Test Sockets	36
Tarak Köprüler	Comb Connector	36
Üst Köprüler	Cross Connections	37
Push-in Üst Köprüler	Push-in Cross Connections	38
Klemens Etiketleri	Marking Tags	39 - 42
Montaj Rayları	Mounting Rails	43
Kanal ve Ray Kesme Makası	Wiring Duct and Din Rail Cutter	44
Pano Tipi Delikli Kablo Kanalları	Panel Type Slotted Wiring Ducts	45 - 46
Markalama Sistemleri	Marking Systems	47 - 53
Plastik Kablo Bağları	Plastic Cable Ties	54
Kroşeler ve Kablo Bağı Sıkma ve Kesme Aleti	Tie Mounts and Cable Tie Tightening and Cutting Tool	55
Kablo Pabuçları ve Ek Muflar	Cable Lugs and Butt Terminals	56 - 63
Kablo Yüksükleri	End Sleeves	64 - 66
Sinyal Lambaları ve Butonlar	Led Indicators and Buttons	67 - 75
Termal İndikatör Kılıflar ve Pullar	Thermal Indicator Covers and Washers	76 - 79

TBLOC 2020 yılının Ocak ayında İzmir’de kurulmuş bir endüstri firmasıdır. Yeni bir firma olmasına rağmen kökleri uzun yıllara dayanan tecrübe ve birikimler nedeniyle çok derindedir. TBLOC, Türkiye’nin yeni bağlantı elemanları markası olarak Ar-Ge, Üretim ve Satış faaliyetlerini tek çatı altında yürütmekte ve bir Türk markası olarak uluslararası standartlarda ürettiği ürünleri tüm dünyaya ihraç etmektedir.

TBLOC markası, klemensin İngilizce karşılığı olan Terminal Block kelimelerinin bir kısaltması olarak görünse de “t” harfi teknolojinin kısaltması olarak markamızın başında, şirketimizin uzun vadeli planlarının göstergesi olarak yerini almıştır.

Tbloc Kurumsal



TBLOC is an industrial company established in January 2020 in İzmir/Turkey. Even though TBLOC is a new company, it has deep roots backed up with long years experience and knowledge. TBLOC, as a new brand in connectivity industry, is gathering all R&D, production and sales & marketing functions under one roof with the aim of becoming a global brand and supplying to international markets.

Despite TBLOC brand is being perceived as an abbreviation of Terminal Block definition, first letter "t" stands for technology and indicates our company's long term vision.

Tbloc Corporate

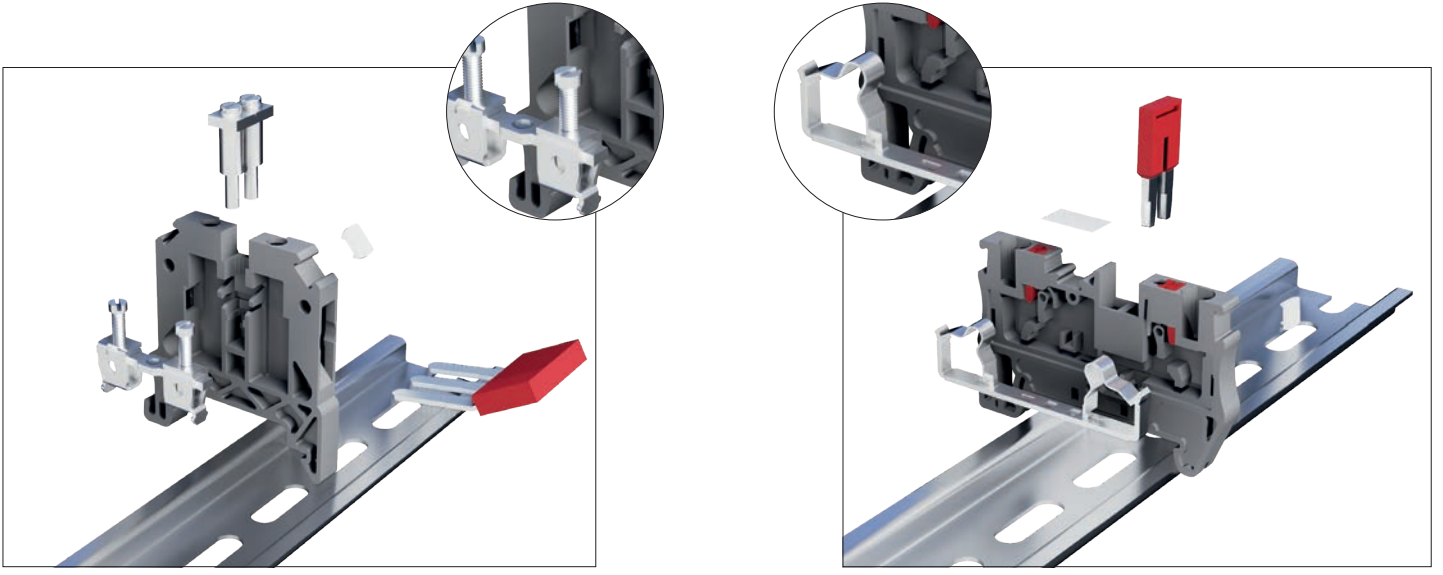

Vida Bağlantısı

Vidalı bağlantı bilinen en klasik bağlantı yöntemidir. Isıl işlem ile güçlendirilmiş sac ayaklar sayesinde uzun dönemde güvenli ve dayanıklı saha kullanımı mümkündür.

Güvenilir Bağlantı Ünitesi

Vidalı klemenslerde yer alan bağlantı ünitesi de (klemens ayağı), vidalarda olduğu gibi güçlendirilmiş çelikten üretilmektedir. Vida sıkıldığında bağlantı ünitesinde meydana gelen kuvvet bir kilitleme mekanizması oluşturur. Bu sistem sayesinde, uzun ömürlü ve güvenli bağlantı elde edilmektedir.

Push-in Bağlantı

Tbloc push-in klemensler, herhangi bir alet kullanmaksızın kolay ve hızlı montaj avantajı sağlamaktadır. Bu bağlantı teknolojisi sayesinde; tek damarlı kablolar ön hazırlığa gerek duymaksızın, çok damarlı kablolar da yüksekli olarak kolayca montajlanabilir. Ayrıca klemens üzerinde yer alan kırmızı butonlar, kullanıcıya klemensin iletken kısımlarına temas etmeden demontaj avantajı sağlamaktadır. Push-in bağlantılı klemensler titreşime karşı dayanıklıdır.

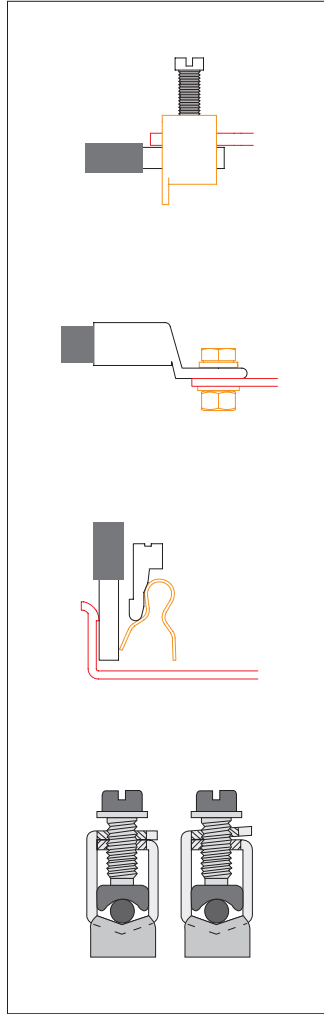

Screw Connection

Screw type connection is the classical method for terminal blocks. Reinforced clamps ensures the safe and durable connection for long time of usage.

Reliable Clamping

The connection unit (yokes) in the terminal block is made of reinforced steel, as in the screw. When the screw is tightened, the force that occurs in the connection unit creates a locking mechanism. Thanks to that, durable and safe connection is obtained.

Push-in Connection

Tbloc push-in terminal blocks provide fast assembly of cables without using a tool. With this technology, solid conductors (just stripping is enough) and flexible conductors (with end ferrules) can be assembled easily. Red buttons on top of the terminal blocks provide easy disassembly without touching conductive parts of the terminal blocks. Push-in connection is resistant to vibration hence can be used safely in many areas.



CERTIFICATE

Issued to:
Applicant:
Tbloc Elektrik Elektronik San. Ve Tic. A.Ş.
29 Ekim MhI. 10001 sok. no:50/4
35663 Menemen Izmir, Turkey

Product : terminal blocks for copper conductors
Trade name(s) : tbloc
Type(s)/model(s) :

- TBL 2.5
- TBL 2.5-4 2P and TDY-C 6
- TBL 4 - TBL 6 - TBL 10 - TBL 16 - TBL 25 - TBL 35 - TBL 50 - TBL 150
- TBL 4 2P
- TDS C 6 - TDT C 6
- PFT 2.5 - PFT 4 - PFT 6
- TBL 2.5 CF - TBL 2.5 S - TBL 2.5 ST - TBL 4 3P
- FDT 4
- NTT 10 E - NTT 2.5 E - NTT 4 E - NTT 6 E
- PFT 2.5 E
- PFT 2.5 1X2 - PFT 2.5 - 2P - PFT 2.5 2X2 - PFT 4 E - PFT 6 E

The product and any acceptable variation thereto is specified in the Annex to this certificate and the documents therein referred to.

DEKRA hereby declares that the above-mentioned product has been certified on the basis of:

- a type test according to the standard EN 60947-7-1:2009
- an inspection of the production location according to CENELEC Operational Document CIG 021
- a certification agreement with the number 2011360
- the licensee is registered with the number 297327

DEKRA hereby grants the right to use the KEMA-KEUR certification mark.

The KEMA-KEUR certification mark may be applied to the product as specified in this certificate for the duration of the KEMA-KEUR certification agreement and under the conditions of the KEMA-KEUR certification agreement.

This certificate is issued on 6 January 2021 and expires upon withdrawal of one of the above mentioned standards.

Certificate number: 71-115286

DEKRA Certification B.V.
B.T.M. Holtus
Managing Director
H.R.M. Barends
Certification Manager

© Integral publication of this certificate is allowed

ACCREDITED BY THE
DUTCH ACCREDITATION
COUNCIL



DEKRA Certification B.V. Meander 1051, 6825 MJ Arnhem P.O. Box 5185, 6802 ED Arnhem, The Netherlands
T +31 88 96 83000 F +31 88 96 83100 www.dekra-product-safety.com Company registration 09085396



VDE Prüf- und Zertifizierungsinstitut

ZEICHENGENEHMIGUNG MARKS APPROVAL

Tbloc Elektrik Elektronik
San. Ve Tic. A.Ş.
29 Ekim MhI. 10001
sok. no:50/4 Menemen
35663 Izmir
Turkey
ist berechtigt, für ihr Produkt /
is authorized to use for their product

**Hilfsstromschalter
Control switch**

die hier abgebildeten markenrechtlich geschützten Zeichen
für die ab Blatt 2 aufgeführten Typen zu benutzen /
the legally protected Marks as shown below for the types referred to on page 2 ff.



Geprüft und zertifiziert nach /
Tested and certified according to



DIN EN 60947-1 (VDE 0660-100):2015-09; EN 60947-1:2007/A1:2011/A2:2014
DIN EN 60947-5-1 (VDE 0660 Teil 200):2018-03; EN 60947-5-1:2017



Aktenzeichen: 5027154-4402-0001 / 276033
File ref.:
Ausweis-Nr. 40052372 Blatt 1
Certificate No. Page
Weitere Bedingungen siehe Rückseite und Folgeblätter /
further conditions see overleaf and following pages
Offenbach, 2020-09-16

VDE Prüf- und Zertifizierungsinstitut GmbH
VDE Testing and Certification Institute
Zertifizierungsstelle / Certification

VDE Zertifikate sind nur gültig bei Veröffentlichung unter:
VDE certificates are valid only when published on: <http://www.vde.com/zertifika>
<http://www.vde.com/certificate>



TÜRKAK TÜRK AKREDITASYON KURUMU TURKISH ACCREDITATION AGENCY tarafından akredite edilmiştir.





TÜV Rheinland
Uluslararası Standartlar Sertifikasyon ve Denetim A.Ş.

Saniye Ermutlu Sokak Çolakoğlu Plaza B Blok No: 12 Kozayağlı-İSTANBUL
Tel: 0 216 665 32 00 - Fax: 0 216 665 32 99
email : info@tr.tuv.com web: www.tr.tuv.com

Deney Raporu
Test report

Müşterinin adı/adresi Customer name/address	TBLOC Elektrik Elektronik San. ve Tic. A.Ş. / 29 Ekim MhI. 10001 Sok. No:50/4 35663, Menemen, Izmir, Turkey
Alıcı Adı Buyer name	/
Sipariş/Artikel Numarası Order/Article No.	/
Numunenin adı ve tanımı Name and identity of test item	Plastic Cable Tie
Numunenin kabul tarihi Date of receipt of test item	2020-09-10(p.m.)
Açıklamalar Remarks	The results given in this test report belong to the received sample by vendor.
Proje tarihi Project date	2020-09-11 to 2020-09-17
Raporun Sayfa Sayısı Number of pages of the Report	5
Test Kapsamı Test Scope	RoHS Directive in electrical and electronic equipment 2011/65/EU & Amendment Directive (EU) 2015/863 by following EN 62321 and its parts
Test Sonucu Test Result	PASS

Türk Akreditasyon kurumu (TÜRKAK) deney raporlarının tanınması konusunda Avrupa Akreditasyon Birliği (EA) ve Uluslararası Laboratuvar Akreditasyon Birliği (ILAC) ile karşılıklı tanıma anlaşmasını imzalamıştır.
The Turkish Accreditation Agency (TÜRKAK) is signatory to the multilateral agreements of the European co-operation for the Accreditation (EA) and of the International Laboratory Accreditation (ILAC) for the Mutual recognition of the test reports.
Deney ve veya ölçüm sonuçları, genişletilmiş ölçüm belirsizlikleri (olması halinde) ve deney metodları bu sertifikanın tamamlayıcı kısmı olan takip eden sayfalarda verilmiştir.
The test and/or measurement results, the uncertainties (if applicable) with confidence probability and test methods are given on the following pages which are part of this report.

Tarih Date	Customer Relations Manager	Chemical Laboratory Assistant Manager
2020-09-17	 Tomris Hasağcebi	 Kıvanç Karataş



TEST REPORT



EUROLAB LABORATUVAR
TÜRCERT TEKNİK KONTROL VE BELGELENDİRME A.Ş.

5190243IB02
2021080443

Overall Rating / Test Sonucu : PASS / GEÇER

Report No/ Rapor No : 2021080443
Applicant/Deney Sahibi : TBLOC ELEKTRİK ELEKTRONİK SAN. VE TİC. A.Ş.
Applicant Address / Adres : 29 Ekim mh. 10001 sk. Ege Sığınak apt. No:50/4 Menemen, Izmir - Türkiye
Contact Person / Yetkili : Hüseyin Açıkgöz
Contact Telephone / Telefon : 0232 833 26 96
Contact e-mail / E-Posta : info@tbloc.com.tr
Sample Accepted on / Numune Tarihi : 01.04.2021
Report Date / Rapor Tarihi : 08.04.2021
Total number of pages / Rapor Sayfa : 5 (Pg/Syf)

Sample ID : SİYAH KABLO BAĞI

TEST	METHOD	REQUIREMENTS	RESULT
UV AGING and UV RESISTANCE TEST	Inhouse Method	240 saat	PASS GEÇER
UV YAŞLANDIRMA ve DAYANIM TESTİ	ISO 4892	-40 °C ila +85 °C	

Seal

Customer Representative

Laboratory Manager

Vida Bağlantılı Ray Klemensleri Screw Type Terminal Blocks

TBL Serisi Geçiş Klemensleri

TBL Series Feed Through Terminal Block



Ürün Adı / Product Name
Sipariş No / Order No.
Paket Adeti / Packing Qty.
Anma Değerleri / Rated Values
IEC 60947-7-1
Bağlantı Bilgileri / Connection Information
Kesit / Cross-Section (mm²)
Tek Damarlı Kablo / Solid Conductor Cross-Section min mm²: (mm²)-(min-max)
Çok Damarlı Kablo / Stranded Conductor Cross-Section (mm²)-(min-max)
Çok Tellî Kablo / Flexible Conductor Cross-Section (mm²)-(min-max)
AWG
Açıklamalar / Descriptions
Kablo Soyma Uzunluğu / Insulation Stripping Length (mm)
Max. Sıkma Torku (N.m) / Max. Tightening Torque
Bağlantı Vidası / Screw Diameter
Darbe Gerilimi / Rated Impulse Voltage (Kv)
Kirlilik Derecesi / Gerilim Kategorisi / Malzeme Grubu / Pollution Degree / Voltage Category / Material Group
Aksesuarlar / Accessories
Montaj Rayı / Din Rail
Durdurucu / End Stopper
Nihayet Plakası / End Plate
Ayırma Plakası / Partition Plate
Mini Ayırma Dili / Small Partition Plate
Üst Köprü / Cross Connection
Tarak Köprü / Comb Connector
Test Fişi / Test Plug
Klemens Etiketi / Marking Tags
Grup Etiketi / Group Label
Tornavida / Screwdriver

Renk Kodları / Color Codes								
800009900....	...0	...1	...2	...3	...4	...5	...6	...9

TBL 2,5

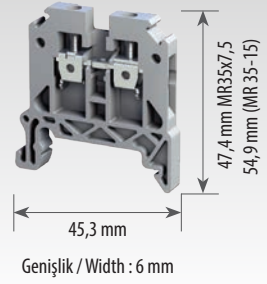

TBL 2,5		
8000099008		
100		
500 V / 24 A		
2,5		
0,5 -4		
0,5 -4		
0,5 -2,5		
20-12 AWG		
10		
0,6		
M2,5		
6		
3 / III / I		
Ürün Adı / Product Name	Sipariş No / Order No.	Adet / Qty.
DR 35-7,5 S 2M	8015393407	40
DR 35-15 S 2M	8015393427	20
SS 1	8010097308	50
SS 2	8010097318	50
PS 1	8010197328	50
EPL TBL 2,5-10	8012396118	50
PR TBL 2,5-10	8012396408	100
SPR 2,5-10	8012396528	100
SCC 2,5/2	8013095023	50
SCC 2,5/3	8013095033	50
SCC 2,5/10	8013095003	10
TST 1	8014393227	50
MTG 6	8020388009	500
GM1	8014393008	50
GM2	8014393018	50
0,5x3,0		

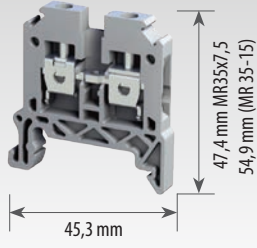
TBL 4

Genişlik / Width : 6,4 mm

**TBL 4**

8000099028

100

800 V / 32 A

4

0,5 - 6

0,5 - 6

0,5 - 4

20-10 AWG

12

0,8

M3

6

3 / III / I

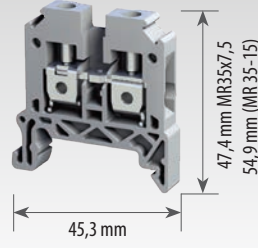
TBL 6

Genişlik / Width : 8 mm

**TBL 6**

8000099038

80

800 V / 41 A

6

0,5 - 10

0,5 - 10

0,5 - 6

20-8 AWG

12

1,2

M3,5

8

3 / III / I

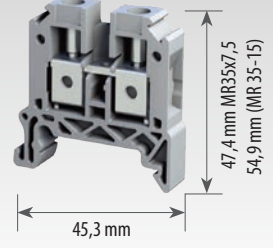
TBL 10

Genişlik / Width : 10 mm

**TBL 10**

8000099048

60

800 V / 57 A

10

0,5 - 16

0,5 - 16

0,5 - 10

20-6 AWG

12

1,5

M4

8

3 / III / I

Ürün Adı Product Name	Sipariş No Order No.	Adet Qty.
DR 35-7,5 S 2M	8015393407	40
DR 35-15 S 2M	8015393427	20
SS 1	8010097308	50
SS 2	8010097318	50
PS 1	8010197328	50
EPL TBL 2,5-10	8012396118	50
PRTBL 2,5 - 10	8012396408	50
SPR 2,5-10	8012396528	100
SCC 4/2	8013095123	50
SCC 4/3	8013095133	50
SCC 4/10	8013095103	10
TCC 4/2	8013094323	50
TCC 4/3	8013094333	50
TCC 4/10	8013094303	10
TST 1	8014393227	50
MTG 6,4	8020387009	500
GM1	8014393008	50
GM2	8014393018	50
0,5x3,0		

Ürün Adı Product Name	Sipariş No Order No.	Adet Qty.
DR 35-7,5 S 2M	8015393407	40
DR 35-15 S 2M	8015393427	20
SS 1	8010097308	50
SS 2	8010097318	50
PS 1	8010197328	50
EPL TBL 2,5-10	8012396118	50
PRTBL 2,5 - 10	8012396408	50
SPR 2,5-10	8012396528	100
SCC 6/2	8013095223	50
SCC 6/3	8013095233	50
SCC 6/10	8013095203	10
TST-I 1	8014393108	50
MTG 8	8020386009	500
GM1	8014393008	50
GM2	8014393018	50
0,6x3,5		

Ürün Adı Product Name	Sipariş No Order No.	Adet Qty.
DR 35-7,5 S 2M	8015393407	40
DR 35-15 S 2M	8015393427	20
SS 1	8010097308	50
SS 2	8010097318	50
PS 1	8010197328	50
EPL TBL 2,5-10	8012396118	50
PRTBL 2,5 - 10	8012396408	50
SPR 2,5-10	8012396528	100
SCC 10/2	8013095323	50
SCC 10/3	8013095333	50
SCC 10/10	8013095303	10
TST-I 1	8014393108	50
MTG 10	8020385009	250
GM1	8014393008	50
GM2	8014393018	50
0,6x3,5		

Vida Bağlantılı Ray Klemensleri Screw Type Terminal Blocks

TBL Serisi Geçiş Klemensleri

TBL Series Feed Through Terminal Block



Ürün Adı / Product Name
Sipariş No / Order No.
Paket Adeti / Packing Qty.
Anma Değerleri / Rated Values
IEC 60947-7-1
Bağlantı Bilgileri / Connection Information
Kesit / Cross-Section (mm²)
Tek Damarlı Kablo / Solid Conductor Cross-Section min mm²: (mm²)-(min-max)
Çok Damarlı Kablo / Stranded Conductor Cross-Section (mm²)-(min-max)
Çok Tellili Kablo / Flexible Conductor Cross-Section (mm²)-(min-max)
AWG
Açıklamalar / Descriptions
Kablo Soyma Uzunluğu / Insulation Stripping Length (mm)
Max. Sıkma Torku (N.m) / Max. Tightening Torque
Bağlantı Vidası / Screw Diameter
Darbe Gerilimi / Rated Impulse Voltage (Kv)
Kirlilik Derecesi / Gerilim Kategorisi / Malzeme Grubu / Pollution Degree / Voltage Category / Material Group
Aksesuarlar / Accessories
Montaj Rayı / Din Rail
Durdurucu / End Stopper
Ayırma Plakası / Partition Plate
Üst Köprü / Cross Connection
Test Fişi / Test Plug
Klemens Etiketi / Marking Tags
Grup Etiketi / Group Label
Tornavida / Screwdriver

TBL 16

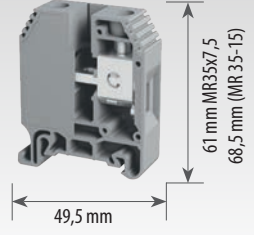

Genişlik / Width : 12,5 mm



TBL 16		
8000099058		
50		
1000 V / 76 A		
16		
0,5 - 16		
0,5 - 16		
0,5 - 16		
20-6 AWG		
12,3		
2,5		
M5		
8		
3 / III / I		
Ürün Adı / Product Name	Sipariş No / Order No.	Adet / Qty.
DR 35-7,5 S 2M	8015393407	40
DR 35-15 S 2M	8015393427	20
SS 1	8010097308	50
SS 2	8010097318	50
PS 1	8010197328	50
GPR	8012396568	20
SCC 16/2	8013095423	20
SCC 16/3	8013095433	20
SCC 16/10	8013095403	10
TST-I 1	8014393108	50
TST 2	8014393237	10
MTG 10	8020385009	250
GM1	8014393008	50
GM2	8014393018	50
1,0x5,5		

Renk Kodları / Color Codes								
800009900....	...0	...1	...2	...3	...4	...5	...6	...9

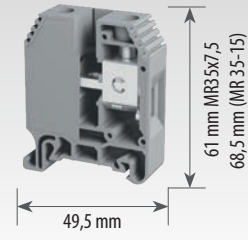
TBL 25

Genişlik / Width : 13,6 mm

**TBL 25**

8000099068

50

1000 V / 101 A

25

0,5 - 25

0,5 - 25

0,5 - 25

20-4 AWG

12,3

2,5

M5

8

3 / III / I

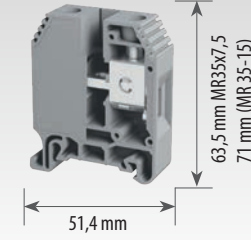
TBL 35

Genişlik / Width : 16,5 mm

**TBL 35**

8000099078

20

1000 V / 125 A

35

1,5 - 35

1,5 - 35

1,5 - 35

16-2 AWG

14,9

3,5

M6

8

3 / III / I

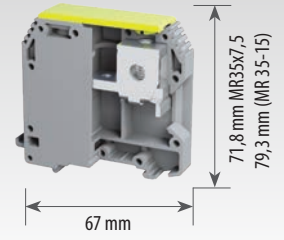
TBL 50

Genişlik / Width : 20,1 mm

**TBL 50**

8000099088

20

1000 V / 150 A

50

6 - 50

6 - 50

10 - 50

10-0 AWG

19

8

M8

8

3 / III / I

Ürün Adı Product Name	Sipariş No Order No.	Adet Qty.
DR 35-7,5 S 2M	8015393407	40
DR 35-15 S 2M	8015393427	20
SS 1	8010097308	50
SS 2	8010097318	50
PS 1	8010197328	50
GPR	8012396568	20
SCC 25/2	8013095523	20
SCC 25/3	8013095533	20
SCC 25/10	8013095503	10
TST-I 1	8014393108	10
TST 2	8014393237	10
MTG 10	8020385009	250
GM1	8014393008	50
GM2	8014393018	50
1,0x5,5		

Ürün Adı Product Name	Sipariş No Order No.	Adet Qty.
DR 35-7,5 S 2M	8015393407	40
DR 35-15 S 2M	8015393427	20
SS 1	8010097308	50
SS 2	8010097318	50
PS 1	8010197328	50
GPR	8012396568	20
SCC 35/2	8013095623	20
SCC 35/3	8013095633	20
SCC 35/10	8013095603	10
TST 4	8014393257	50
MTG 10	8020385009	250
GM1	8014393008	50
GM2	8014393018	50
1,2x6,5		

Ürün Adı Product Name	Sipariş No Order No.	Adet Qty.
DR 35-7,5 S 2M	8015393407	40
DR 35-15 S 2M	8015393427	20
SS 1	8010097308	50
SS 2	8010097318	50
PS 1	8010197328	50
GPR	8012396568	20
SCC 50/2	8013095723	10
SCC 50/3	8013095733	10
MTG 10	8020385009	250
GM1	8014393008	50
GM2	8014393018	50
Alyen / Allen Wrench 4		

Vida Bağlantılı Ray Klemensleri Screw Type Terminal Blocks

TBL Serisi Geçiş Klemensleri

TBL Series Feed Through Terminal Block



Ürün Adı / Product Name
Sipariş No / Order No.
Paket Adeti / Packing Qty.
Anma Değerleri / Rated Values
IEC 60947-7-1
Bağlantı Bilgileri / Connection Information
Kesit / Cross-Section (mm ²)
Tek Damarlı Kablo / Solid Conductor Cross-Section min mm ² : (mm ²)-(min-max)
Çok Damarlı Kablo / Stranded Conductor Cross-Section (mm ²)-(min-max)
Çok Tellli Kablo / Flexible Conductor Cross-Section (mm ²)-(min-max)
AWG
Açıklamalar / Descriptions
Kablo Soyma Uzunluğu / Insulation Stripping Length (mm)
Max. Sıkma Torku (N.m) / Max. Tightening Torque
Bağlantı Vidası / Screw Diameter
Darbe Gerilimi / Rated Impulse Voltage (Kv)
Kirlilik Derecesi / Gerilim Kategorisi / Malzeme Grubu / Pollution Degree / Voltage Category / Material Group
Aksesuarlar / Accessories
Montaj Rayı / Din Rail
Durdurucu / End Stopper
Üst Köprü / Cross Connection
Klemens Etiketi / Marking Tags
Grup Etiketi / Group Label
Alyen / Allen Wrench

TBL 70

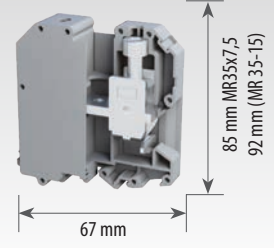

TBL 70		
8000099098		
10		
1000 V / 192 A		
70		
6 - 70		
6 - 70		
10 - 70		
8-0 AWG		
19		
10		
M8		
8		
3 / III / I		
Ürün Adı Product Name	Sipariş No Order No.	Adet Qty.
DR 35-7,5 S 2M	8015393407	40
DR 35-15 S 2M	8015393427	20
SS 1	8010097308	50
SS 2	8010097318	50
PS 1	8010197328	50
SCC 70/2	8013095823	10
SCC 70/3	8013095833	10
MTG 10	8020385009	250
GM1	8014393008	50
GM2	8014393018	50
6		

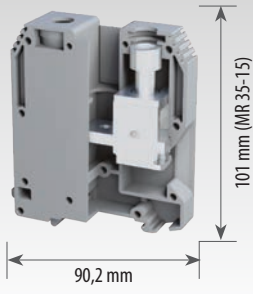
TBL 95

Genişlik / Width : 25,3 mm

**TBL 95**

8000099108

5

1000 V / 232 A

95

6 - 95

6 - 95

10 - 95

10-3/0 AWG

24,5

14

M8

8

3 / III / I

Ürün Adı Product Name	Sipariş No Order No.	Adet Qty.
DR 35-7,5 S 2M	8015393407	40
DR 35-15 S 2M	8015393427	20
SS 1	8010097308	50
SS 2	8010097318	50
PS 1	8010197328	50
SCC 95/2	8013095923	10
SCC 95/3	8013095933	10
MTG 10	8020385009	250
GM1	8014393008	50
GM2	8014393018	50
6		

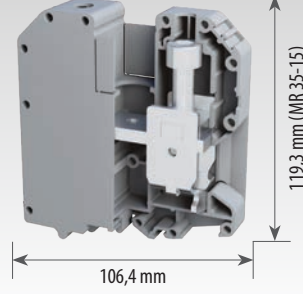
TBL 150

Genişlik / Width : 31 mm

**TBL 150**

8000099118

5

1000 V / 309 A

150

6 - 150

6 - 150

10 - 150

10-300 kcmil

27

22

M10

8

3 / III / I

Ürün Adı Product Name	Sipariş No Order No.	Adet Qty.
DR 35-7,5 S 2M	8015393407	40
DR 35-15 S 2M	8015393427	20
SS 1	8010097308	50
SS 2	8010097318	50
PS 1	8010197328	50
SCC 150/2	8013094023	10
MTG 10	8020385009	250
GM1	8014393008	50
GM2	8014393018	50
8		

Vida Bağlantılı Ray Klemensleri Screw Type Terminal Blocks

Yüksek Akım Klemensi High Current Terminal Blocks



Ürün Adı / Product Name
Sipariş No / Order No.
Paket Adeti / Packing Qty.
Anma Değerleri / Rated Values
IEC 60947-7-1
Bağlantı Bilgileri / Connection Information
Kesit / Cross-Section (mm²)
Delik Çapı ve Bara Ölçüsü (mm) / Hole Diameter & Power Rail
DIN 46234 Norm Pabuç (min-max) (mm²) / Cable Lugs DIN 46234
DIN 46235 Norm Pabuç (min-max) (mm²) / Cable Lugs DIN 46235
AWG Kesit Aralığı DIN 46234 / AWG
AWG Kesit Aralığı DIN 46235 / AWG
Açıklamalar / Descriptions
Max. Sıkma Torku (N.m) / Max. Tightening Torque
Bağlantı Vidası / Screw Diameter
Darbe Gerilimi / Rated Impulse Voltage (kV)
Kirlilik Derecesi / Gerilim Kategorisi / Malzeme Grubu / Pollution Degree / Voltage Category / Material Group
Aksesuarlar / Accessories
Montaj Rayı / Din Rail
Koruma Kapağı / Isolation Cover
Durdurucu / End Stopper
Klemens Etiketi / Marking Tags
Grup Etiketi / Group Label

* Koruma kapakları ayrı satılmaktadır. (C-TBB)
* Isolation covers are sold separately. (C-TBB)

TBB 70

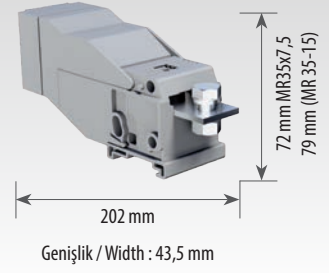

TBB 70		
8000099128		
5		
1000 V / 192 A		
70		
9/25x3		
2,5 - 70		
16 - 70		
14-2/0		
6-2/0		
15-20		
M8		
8		
3 / III / I		
Ürün Adı Product Name	Sipariş No Order No.	Adet Qty.
DR 35-7,5 S 2M	8015393407	40
DR 35-15 S 2M	8015393427	20
C-TBB 70-95-150	8012396608	8
SS 1	8010097308	50
SS 2	8010097318	50
PS 1	8010197328	50
MTG 5	8020389009	500
GM1	8014393008	50
GM2	8014393018	50

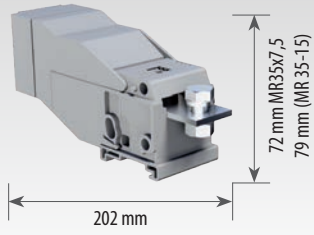
TBB 95

Genişlik / Width : 43,5 mm

**TBB 95**

8000099138

5

1000 V / 232 A

95

11/25x5

6 - 95

16 - 95

10-3/0

6-3/0

25-30

M10

8

3 / III / I

Ürün Adı Product Name	Sipariş No Order No.	Adet Qty.
DR 35-7,5 S 2M	8015393407	40
DR 35-15 S 2M	8015393427	20
C-TBB 70-95-150	8012396608	8
SS 1	8010097308	50
SS 2	8010097318	50
PS 1	8010197328	50
MTG 5	8020389009	500
GM1	8014393008	50
GM2	8014393018	50

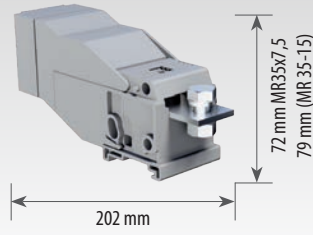
TBB 150

Genişlik / Width : 43,5 mm

**TBB 150**

8000099148

5

1000 V / 309 A

150

13/30x5

10 - 150

25 - 150

8-300 Kcmil

4-300 Kcmil

25-30

M12

8

3 / III / I

Ürün Adı Product Name	Sipariş No Order No.	Adet Qty.
DR 35-7,5 S 2M	8015393407	40
DR 35-15 S 2M	8015393427	20
C-TBB 70-95-150	8012396608	8
SS 1	8010097308	50
SS 2	8010097318	50
PS 1	8010197328	50
MTG 5	8020389009	500
GM1	8014393008	50
GM2	8014393018	50

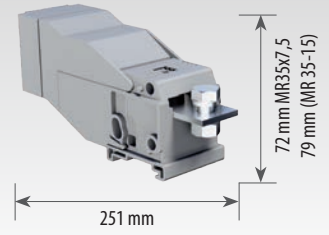
TBB 240

Genişlik / Width : 46,0 mm

**TBB 240**

8000099158

4

1000 V / 415 A

240

17/29,7x9,7

25 - 240

50 - 185

4-500 Kcmil

0-350 Kcmil

30-35

M16

8

3 / III / I

Ürün Adı Product Name	Sipariş No Order No.	Adet Qty.
DR 35-7,5 S 2M	8015393407	40
DR 35-15 S 2M	8015393427	20
C-TBB 240	8012396618	10
SS 1	8010097308	50
SS 2	8010097318	50
PS 1	8010197328	50
MTG 5	8020389009	500
GM1	8014393008	50
GM2	8014393018	50

* Koruma kapakları ayrı satılmaktadır. (C-TBB)

* Isolation covers are sold separately. (C-TBB)

Vida Bağlantılı Ray Klemensleri Screw Type Terminal Blocks

Topraklama Klemensleri Earth Terminal Blocks



Ürün Adı / Product Name
Sipariş No / Order No.
Paket Adeti / Packing Qty.
Anma Değerleri / Rated Values
IEC 60947-7-1
Bağlantı Bilgileri / Connection Information
Kesit / Cross-Section (mm²)
Tek Damarlı Kablo / Solid Conductor Cross-Section min mm²: (mm²)-(min-max)
Çok Damarlı Kablo / Stranded Conductor Cross-Section (mm²)-(min-max)
Çok Tellî Kablo / Flexible Conductor Cross-Section (mm²)-(min-max)
AWG
Açıklamalar / Descriptions
Kablo Soyma Uzunluğu / Insulation Stripping Length (mm)
Max. Sıkma Torkü (N.m) / Max. Tightening Torque
Bağlantı Vidası / Screw Diameter
Darbe Gerilimi / Rated Impulse Voltage (kV)
Kirlilik Derecesi / Gerilim Kategorisi / Malzeme Grubu / Pollution Degree / Voltage Category / Material Group
Aksesuarlar / Accessories
Montaj Rayı / Din Rail
Durdurucu / End Stopper
Nihayet Plakası / End Plate
Klemens Etiketli / Marking Tags
Grup Etiketli / Group Label
Tornavida / Screwdriver

NTT 2,5 E

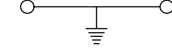
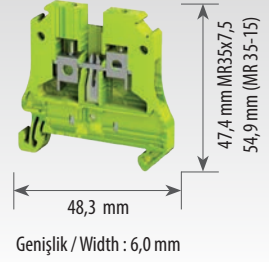

NTT 2,5 E

8001099214

50

2,5

0,5 - 4

0,5 - 4

0,5 - 2,5

20-12 AWG

10

0,6

M2,5

6

3 / III / I

Ürün Adı Product Name	Sipariş No Order No.	Adet Qty.
DR 35-7,5 S 2M	8015393407	40
DR 35-15 S 2M	8015393427	20
PS 1	8010197328	50
EPL TBL 2,5-10	8012396118	50
MTG 6	8020388009	500
GM1	8014393008	50
GM2	8014393018	50
0,5x3,0		

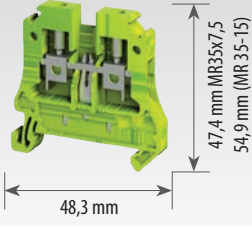
NTT 4 E

Genişlik / Width : 6,5 mm

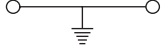
**NTT 4 E**

8001099224

50

4

0,5 - 4

0,5 - 4

0,5 - 4

20-12 AWG

12

0,8

M3

6

3 / III / I

Ürün Adı Product Name	Sipariş No Order No.	Adet Qty.
DR 35-7,5 S 2M	8015393407	40
DR 35-15 S 2M	8015393427	20
PS 1	8010197328	50
EPL TBL 2,5-10	8012396118	50
MTG 6,4	8020387009	500
GM1	8014393008	50
GM2	8014393018	50
0,5x3,0		

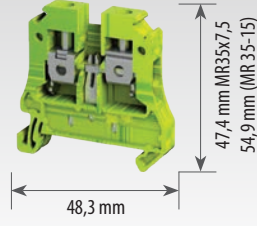
NTT 6 E

Genişlik / Width : 8,0 mm

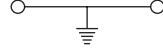
**NTT 6 E**

8001099234

25

6

0,5 - 10

0,5 - 10

0,5 - 6

20-8 AWG

12

1,2

M4

8

3 / III / I

Ürün Adı Product Name	Sipariş No Order No.	Adet Qty.
DR 35-7,5 S 2M	8015393407	40
DR 35-15 S 2M	8015393427	20
PS 1	8010197328	50
EPL TBL 2,5-10	8012396118	50
MTG 8	8020386009	500
GM1	8014393008	50
GM2	8014393018	50
1,0x5,5		

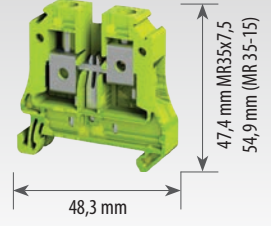
NTT 10 E

Genişlik / Width : 10,0 mm

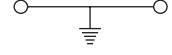
**NTT 10 E**

8001099244

20

10

0,5 - 16

0,5 - 16

0,5 - 10

20-6 AWG

12

1,5

M6

8

3 / III / I

Ürün Adı Product Name	Sipariş No Order No.	Adet Qty.
DR 35-7,5 S 2M	8015393407	40
DR 35-15 S 2M	8015393427	20
PS 1	8010197328	50
EPL TBL 2,5-10	8012396118	50
MTG 10	8020385009	250
GM1	8014393008	50
GM2	8014393018	50
1,0x5,5		

Vida Bağlantılı Ray Klemensleri Screw Type Terminal Blocks

Topraklama Klemensleri Earth Terminal Blocks



Ürün Adı / Product Name
Sipariş No / Order No.
Paket Adeti / Packing Qty.
Anma Değerleri / Rated Values
IEC 60947-7-1
Bağlantı Bilgileri / Connection Information
Kesit / Cross-Section (mm ²)
Tek Damarlı Kablo / Solid Conductor Cross-Section min mm ² : (mm ²)-(min-max)
Çok Damarlı Kablo / Stranded Conductor Cross-Section (mm ²)-(min-max)
Çok Tellli Kablo / Flexible Conductor Cross-Section (mm ²)-(min-max)
AWG
Açıklamalar / Descriptions
Kablo Soyma Uzunluğu / Insulation Stripping Length (mm)
Max. Sıkma Torku (N.m) / Max. Tightening Torque
Bağlantı Vidası / Screw Diameter
Darbe Gerilimi / Rated Impulse Voltage (kV)
Kirlilik Derecesi / Gerilim Kategorisi / Malzeme Grubu / Pollution Degree / Voltage Category / Material Group
Aksesuarlar / Accessories
Montaj Rayı / Din Rail
Durdurucu / End Stopper
Ayırma Plakası / Partition Plate
Klemens Etiketi / Marking Tags
Tornavida / Screwdriver

TBL 16 E

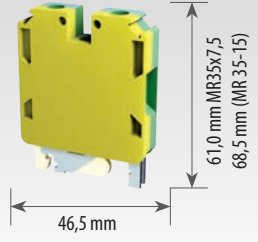

Genişlik / Width : 12,5 mm

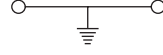

TBL 16 E

8001099194

20

16

0,5 - 16

0,5 - 16

0,5 - 16

20-6 AWG

12,3

1,2

M5

8

3 / III / I

Ürün Adı Product Name	Sipariş No Order No.	Adet Qty.
DR 35-7,5 S 2M	8015393407	40
DR 35-15 S 2M	8015393427	20
SS 1	8010097308	50
SS 2	8010097318	50
PS 1	8010197328	50
GPR	8012396568	20
MTG 10	8020385009	250
1,0x5,5		

TBL 35 E

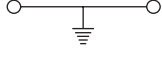
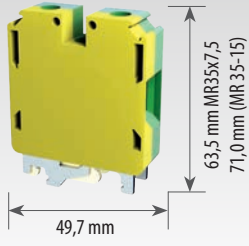

TBL 35 E

8001099204

20

35

1,5 - 35

1,5 - 35

1,5 - 35

16-2 AWG

14,9

3,5

M6

8

3 / III / I

Ürün Adı Product Name	Sipariş No Order No.	Adet Qty.
DR 35-7,5 S 2M	8015393407	40
DR 35-15 S 2M	8015393427	20
SS 1	8010097308	50
SS 2	8010097318	50
PS 1	8010197328	50
GPR	8012396568	20
MTG 10	8020385009	250
1,2x6,5		

Vida Bağlantılı Ray Klemensleri Screw Type Terminal Blocks

Çok Katlı Klemensler Multilevel Terminal Blocks



Ürün Adı / Product Name
Sipariş No / Order No.
Paket Adeti / Packing Qty.
Anma Değerleri / Rated Values
IEC 60947-7-1
Bağlantı Bilgileri / Connection Information
Kesit / Cross-Section (mm²)
Tek Damarlı Kablo / Solid Conductor Cross-Section min mm²: (mm²)-(min-max)
Çok Damarlı Kablo / Stranded Conductor Cross-Section (mm²)-(min-max)
Çok Tellî Kablo / Flexible Conductor Cross-Section (mm²)-(min-max)
AWG
Açıklamalar / Descriptions
Kablo Soyma Uzunluğu / Insulation Stripping Length (mm)
Max. Sıkma Torku (N.m) / Max. Tightening Torque
Bağlantı Vidası / Screw Diameter
Darbe Gerilimi / Rated Impulse Voltage (Kv)
Kirlilik Derecesi / Gerilim Kategorisi / Malzeme Grubu / Pollution Degree / Voltage Category / Material Group
Aksesuarlar / Accessories
Montaj Rayı / Din Rail
Durdurucu / End Stopper
Nihayet Plakası / End Plate
Ayırma Plakası / Partition Plate
Mini Ayırma Dili / Small Partition Plate
Üst Köprü / Cross Connection
Test Fişi / Test Plug
Klemens Etiketi / Marking Tags
Grup Etiketi / Group Label
Tornavida / Screwdriver

TBL 2,5-4 2P



TBL 2,5-4 2P

8002099438

50

500 V / 32 A

2,5 - 4

0,5 - 4

0,5 - 4

0,5 - 4

20-12 AWG

9

0,4

M2,5

6

3 / III / I

Ürün Adı Product Name	Sipariş No Order No.	Adet Qty.
DR 35-7,5 S 2M	8015393407	40
DR 35-15 S 2M	8015393427	20
SS 1	8010097308	50
SS 2	8010097318	50
PS 1	8010197328	50
EPL TBL 2,5-4 2P	8012396208	20
PR TBL 4 2P	8012396508	20
SPR TBL 4 2P	8012396558	100
SCC 2,5/2	8013095023	50
SCC 2,5/3	8013095033	50
SCC 2,5/10	8013095003	10
TST 1	8014393227	50
MTG 6	8020388009	500
GM1	8014393008	50
GM2	8014393018	50
0,5x3,0		

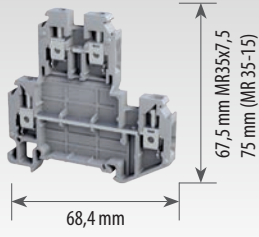
TBL 4 2 P

Genişlik / Width : 6,4 mm

**TBL 4 2P**

8002099258

50

500 V / 32 A

4

0,5 - 4

0,5 - 4

0,5 - 4

20-12 AWG

9

0,4

M2,5

6

3 / III / I

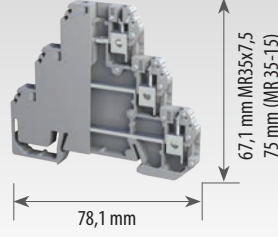
TBL 4 3 P

Genişlik / Width : 6,4 mm

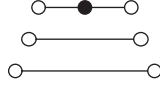
**TBL 4 3P**

8002099478

25

400 V / 32 A

4

0,5 - 4

0,5 - 4

0,5 - 4

20-12 AWG

9

0,4

M2,5

6

3 / III / I

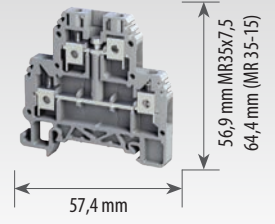
TBL 2,5-4 2PK

Genişlik / Width : 6,0 mm

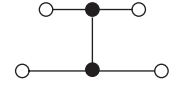
**TBL 2,5-4 2PK**

8002099448

50

500 V / 32 A

2,5 - 4

0,5 - 4

0,5 - 4

0,5 - 4

20-12 AWG

9

0,4

M2,5

6

3 / III / I

Ürün Adı Product Name	Sipariş No Order No.	Adet Qty.
DR 35-7,5 S 2M	8015393407	40
DR 35-15 S 2M	8015393427	20
SS 1	8010097308	50
SS 2	8010097318	50
PS 1	8010197328	50
EPL1 TBL 4 2P	8012396218	20
EPL2 TBL 4 2P	8012396228	20
GPR	8012396568	20
SCC 4/2 TBL 4 2P	8013094123	50
SCC 4/3 TBL 4 2P	8013094133	50
SCC 4/10 TBL 4 2P	8013094103	10
TST 1	8014393227	50
MTG 6,4	8020387009	500
GM1	8014393008	50
GM2	8014393018	50
0,5x3,0		

Ürün Adı Product Name	Sipariş No Order No.	Adet Qty.
DR 35-7,5 S 2M	8015393407	40
DR 35-15 S 2M	8015393427	20
SS 1	8010097308	50
SS 2	8010097318	50
PS 1	8010197328	50
EPL1 TBL 4 2P	8012396218	20
EPL2 TBL 4 2P	8012396228	20
GPR	8012396568	20
SCC 4/2 TBL 4 2P	8013094123	50
SCC 4/3 TBL 4 2P	8013094133	50
SCC 4/10 TBL 4 2P	8013094103	10
TST 1	8014393227	50
MTG 6,4	8020387009	500
GM1	8014393008	50
GM2	8014393018	50
0,5x3,0		

Ürün Adı Product Name	Sipariş No Order No.	Adet Qty.
DR 35-7,5 S 2M	8015393407	40
DR 35-15 S 2M	8015393427	20
SS 1	8010097308	50
SS 2	8010097318	50
PS 1	8010197328	50
EPL TBL 2,5-4 2P	8012396208	20
GPR	8012396568	20
SCC 4/2 TBL 4 2P	8013094123	50
SCC 4/3 TBL 4 2P	8013094133	50
SCC 4/10 TBL 4 2P	8013094103	10
TST 1	8014393227	50
MTG 6	8020388009	500
GM1	8014393008	50
GM2	8014393018	50
0,5x3,0		

Vida Bağlantılı Ray Klemensleri Screw Type Terminal Blocks

Sigortalı ve Bıçaklı Ayırma Klemensleri Fuse and Disconnect Terminal Blocks



Ürün Adı / Product Name
Sipariş No / Order No.
Paket Adeti / Packing Qty.
Anma Değerleri / Rated Values
IEC 60947-7-3 (FDT 4) / IEC 60947-7-1 (TBL S)
Bağlantı Bilgileri / Connection Information
Kesit / Cross-Section (mm²)
Tek Damarlı Kablo / Solid Conductor Cross-Section min mm²: (mm²)-(min-max)
Çok Damarlı Kablo / Stranded Conductor Cross-Section (mm²)-(min-max)
Çok Tellî Kablo / Flexible Conductor Cross-Section (mm²)-(min-max)
AWG
Açıklamalar / Descriptions
Kablo Soyma Uzunluğu / Insulation Stripping Length (mm)
Max. Sıkma Torku (N.m) / Max. Tightening Torque
Bağlantı Vidası / Screw Diameter
Darbe Gerilimi / Rated Impulse Voltage (Kv)
Kirlilik Derecesi / Gerilim Kategorisi / Malzeme Grubu / Pollution Degree / Voltage Category / Material Group
Aksesuarlar / Accessories
Montaj Rayı / Din Rail
Durdurucu / End Stopper
Tarak Köprü / Comb Connector
Klemens Etiketleri / Marking Tags
Grup Etiketleri / Group Label
Tornavida / Screwdriver

FDT 4

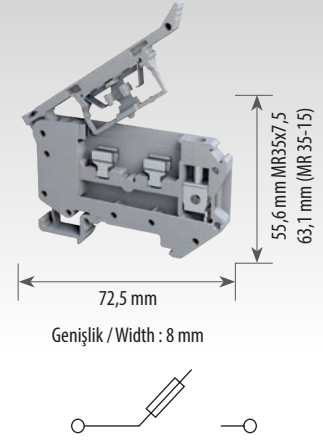

FDT 4		
8003099488		
25		
800 V / 6,3 A		
4		
0,5 - 4		
0,5 - 4		
0,5 - 4		
20-12 AWG		
12		
0,5		
M3		
8		
3 / III / I		
Ürün Adı Product Name	Sipariş No Order No.	Adet Qty.
DR 35-7,5 S 2M	8015393407	40
DR 35-15 S 2M	8015393427	20
SS 1	8010097308	50
SS 2	8010097318	50
PS 1	8010197328	50
TCC 6/2	8013394823	50
TCC 6/3	8013394833	50
TCC 6/10	8013394803	50
MTG 8	8020386009	500
GM1	8014393008	50
GM2	8014393018	50
0,5x3,0		

TBL 2,5 S

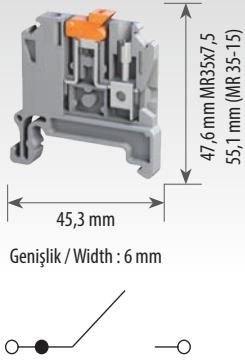

TBL 2,5 S

8003099528

25

500 V / 17,5 A

2,5

0,5 - 4

0,5 - 4

0,5 - 4

20-12 AWG

9

0,4

M2,5

6

3 / III / I

Ürün Adı Product Name	Sipariş No Order No.	Adet Qty.
DR 35-7,5 S 2M	8015393407	40
DR 35-15 S 2M	8015393427	20
SS 1	8010097308	50
SS 2	8010097318	50
PS 1	8010197328	50
MTG 6	8020388009	500
GM1	8014393008	50
GM2	8014393018	50
0,5x3,0		

* Sigortalı ve bıçaklı ayırma klemenslerimiz iki tarafı kapalı tipte olduğundan, nihayet plakası seçimine gerek yoktur.

* Fuse and disconnect type terminal blocks are double side closed, no need for an extra end plate usage.

Vida Bağlantılı Ray Klemensleri Screw Type Terminal Blocks

Ölçme Ayırma Klemensleri Test and Disconnect Terminal Blocks



Ürün Adı / Product Name
Sipariş No / Order No.
Paket Adeti / Packing Qty.
Anma Değerleri / Rated Values
IEC 60947-7-1
Bağlantı Bilgileri / Connection Information
Kesit / Cross-Section (mm ²)
Tek Damarlı Kablo / Solid Conductor Cross-Section min mm ² : (mm ²)-(min-max)
Çok Damarlı Kablo / Stranded Conductor Cross-Section (mm ²)-(min-max)
Çok Tellli Kablo / Flexible Conductor Cross-Section (mm ²)-(min-max)
AWG
Açıklamalar / Descriptions
Kablo Soyma Uzunluğu / Insulation Stripping Length (mm)
Max. Sıkma Torku (N.m) / Max. Tightening Torque
Bağlantı Vidası / Screw Diameter
Darbe Gerilimi / Rated Impulse Voltage (Kv)
Kirlilik Derecesi / Gerilim Kategorisi / Malzeme Grubu / Pollution Degree / Voltage Category / Material Group
Merkez Vida / Sıkma Torku (N.m) / Center Screw / Tightening Torque
Aksesuarlar / Accessories
Montaj Rayı / Din Rail
Durdurucu / End Stopper
Nihayet Plakası / End Plate Section
Kayar Köprü / Swipe Connector
Tarak Köprü / Comb Connector
Test Fişi / Test Plug
Klemens Etiketi / Marking Tags
Grup Etiketi / Group Label
Tornavida / Screwdriver

TDT-C 6

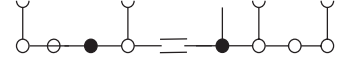
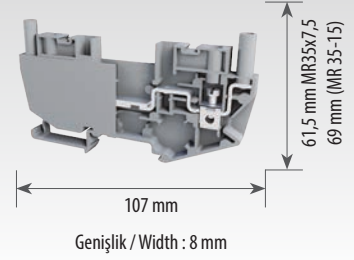

TDT-C 6		
8004099808		
20		
400 V / 41 A		
6		
0,5 - 10		
0,5 - 10		
0,5 - 6		
20-8 AWG		
12		
1,2		
M3,5		
6		
3 / III / I		
M3 / 0,5		
Ürün Adı Product Name	Sipariş No Order No.	Adet Qty.
DR 35-7,5 S 2M	8015393407	40
DR 35-15 S 2M	8015393427	20
SS 1	8010097308	50
SS 2	8010097318	50
PS 1	8010197328	50
SLC 2	8013394923	50
SLC 3	8013394933	50
SLC 4	8013394943	50
TCC 6/2	8013394823	50
TCC 6/3	8013394833	50
TCC 6/10	8013394803	10
TST-1 1	8014393108	50
MTG 8	8020386009	500
GM1	8014393008	50
GM2	8014393018	50
0,5x3.0 / 0,6x3,5		

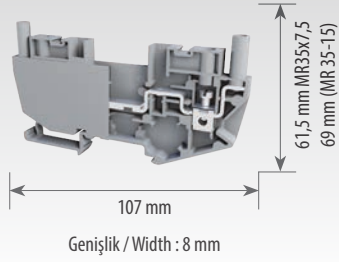
TDT-V 6**TDT-V 6**

8004099818

20

400 V / 41 A

6

0,5 - 10

0,5 - 10

0,5 - 6

20-8 AWG

12

1,2

M3,5

6

3 / III / I

M3 / 0,5

Ürün Adı Product Name	Sipariş No Order No.	Adet Qty.
DR 35-7,5 S 2M	8015393407	40
DR 35-15 S 2M	8015393427	20
SS 1	8010097308	50
SS 2	8010097318	50
PS 1	8010197328	50
SLC 2	8013394923	50
SLC 3	8013394933	50
SLC 4	8013394943	50
TCC 6/2	8013394823	50
TCC 6/3	8013394833	50
TCC 6/10	8013394803	10
TST-I 1	8014393108	50
MTG 8	8020386009	500
GM1	8014393008	50
GM2	8014393018	50
0,6x3,5		

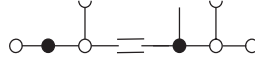
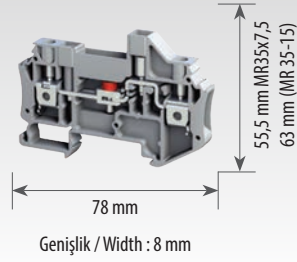
TDS-C 6**TDS-C 6**

8004099828

25

400 V / 41 A

6

0,5 - 10

0,5 - 10

0,5 - 6

20-8 AWG

12

1,2

M3,5

6

3 / III / I

M3 / 0,5

Ürün Adı Product Name	Sipariş No Order No.	Adet Qty.
DR 35-7,5 S 2M	8015393407	40
DR 35-15 S 2M	8015393427	20
SS 1	8010097308	50
SS 2	8010097318	50
PS 1	8010197328	50
EPL TDS	8012396018	50
SLC 2	8013394923	50
SLC 3	8013394933	50
SLC 4	8013394943	50
TCC 6/2	8013394823	50
TCC 6/3	8013394833	50
TCC 6/10	8013394803	10
TST-I 1	8014393108	50
MTG 8	8020386009	500
GM1	8014393008	50
GM2	8014393018	50
0,5x3,0 / 0,6x3,5		

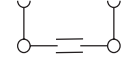
TDV-C 6**TDV-C 6**

8004099838

25

500 V / 41 A

6

0,5 - 10

0,5 - 10

0,5 - 6

20-8 AWG

12

1,2

M3,5

6

3 / III / I

M3 / 0,5

Ürün Adı Product Name	Sipariş No Order No.	Adet Qty.
DR 35-7,5 S 2M	8015393407	40
DR 35-15 S 2M	8015393427	20
SS 1	8010097308	50
SS 2	8010097318	50
PS 1	8010197328	50
EPL TDV	8012396028	50
TCC 6/2	8013394823	50
TCC 6/3	8013394833	50
TCC 6/10	8013394803	10
TST-I 1	8014393108	50
MTG 5	8020389009	500
GM1	8014393008	50
GM2	8014393018	50
1,0x5,5		

Vida Bağlantılı Ray Klemensleri Screw Type Terminal Blocks

Ölçme Ayırma Klemensleri Test and Disconnect Terminal Blocks



Ürün Adı / Product Name
Sipariş No / Order No.
Paket Adeti / Packing Qty.
Anma Değerleri / Rated Values
IEC 60947-7-1
Bağlantı Bilgileri / Connection Information
Kesit / Cross-Section (mm ²)
Tek Damarlı Kablo / Solid Conductor Cross-Section min mm ² : (mm ²)-(min-max)
Çok Damarlı Kablo / Stranded Conductor Cross-Section (mm ²)-(min-max)
Çok Tellili Kablo / Flexible Conductor Cross-Section (mm ²)-(min-max)
AWG
Açıklamalar / Descriptions
Kablo Soyma Uzunluğu / Insulation Stripping Length (mm)
Max. Sıkma Torku (N.m) / Max. Tightening Torque
Bağlantı Vidası / Screw Diameter
Darbe Gerilimi / Rated Impulse Voltage (Kv)
Kirlilik Derecesi / Gerilim Kategorisi / Malzeme Grubu / Pollution Degree / Voltage Category / Material Group
Merkez Vida / Sıkma Torku (N.m) / Center Screw / Tightening Torque
Aksesuarlar / Accessories
Montaj Rayı / Din Rail
Durdurucu / End Stopper
Nihayet Plakası / End Plate Section
Kayar Köprü / Swipe Connector
Tarak Köprü / Comb Connector
Test Fişi / Test Plug
Klemens Etiketi / Marking Tags
Grup Etiketi / Group Label
Tornavida / Screwdriver

TDS-V 6

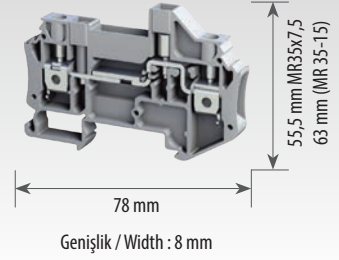

TDS-V 6
8004099848
25
400 V
6
0,5 - 10
0,5 - 10
0,5 - 6
20-8 AWG
12
1,2
M3,5
6
3 / III / I

Ürün Adı Product Name	Sipariş No Order No.	Adet Qty.
DR 35-7,5 S 2M	8015393407	40
DR 35-15 S 2M	8015393427	20
SS 1	8010097308	50
SS 2	8010097318	50
PS 1	8010197328	50
EPL TDS	8012396018	50
SLC 2	8013394923	50
SLC 3	8013394933	50
SLC 4	8013394943	50
TCC 6/2	8013394823	50
TCC 6/3	8013394833	50
TCC 6/10	8013394803	10
TST-1 1	8014393108	50
MTG 8	8020386009	500
GM1	8014393008	50
GM2	8014393018	50
0,6x3,5		

TDY-C 6

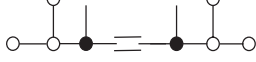
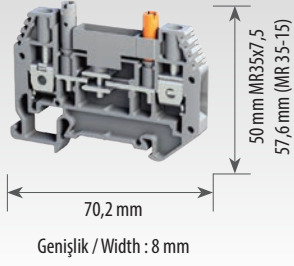

TDY-C 6

8004099858

25

400 V

6

0,5 - 10

0,5 - 10

0,5 - 6

20-8 AWG

12

0,5

M3,5

6

3 / III / I

M3 / 0,5

Ürün Adı Product Name	Sipariş No Order No.	Adet Qty.
DR 35-7,5 S 2M	8015393407	40
DR 35-15 S 2M	8015393427	20
SS 1	8010097308	50
SS 2	8010097318	50
PS 1	8010197328	50
EPL TDY	8012396038	50
SLC-R 2	8014393307	50
SLC-R 3	8014393317	50
SLC-R 4	8014393327	50
TCC 6/2	8013394823	50
TCC 6/3	8013394833	50
TCC 6/10	8013394803	10
TST-I 1	8014393108	50
MTG 8	8020386009	500
GM1	8014393008	50
GM2	8014393018	50
0,6x3,5 / 0,5x3.0		

Push-in Klemensleri Push-in Terminal Blocks

Geçiş Klemensleri Feed Through Terminal Blocks



Ürün Adı / Product Name
Sipariş No / Order No.
Paket Adeti / Packing Qty.
Anma Değerleri / Rated Values
IEC 60947-7-1
Bağlantı Bilgileri / Connection Information
Kesit / Cross-Section (mm²)
Tek Damarlı Kablo / Solid Conductor Cross-Section min mm²: (mm²)-(min-max)
Çok Damarlı Kablo / Stranded Conductor Cross-Section (mm²)-(min-max)
Çok Telli Kablo / Flexible Conductor Cross-Section (mm²)-(min-max)
AWG
Açıklamalar / Descriptions
Kablo Soyma Uzunluğu / Insulation Stripping Length (mm)
Max. Sıkma Torku (N.m) / Max. Tightening Torque
Bağlantı Vidası / Screw Diameter
Darbe Gerilimi / Rated Impulse Voltage (Kv)
Kirlilik Derecesi / Gerilim Kategorisi / Malzeme Grubu / Pollution Degree / Voltage Category / Material Group
Aksesuarlar / Accessories
Montaj Rayı / Din Rail
Durdurucu / End Stopper
Üst Köprü / Cross Connection
Klemens Etiketi / Marking Tags
Şerit Etiket / Strip Label
Grup Etiketi / Group Label

* PFT Serisi klemenslerimiz iki tarafı kapalı tipte olduğundan, nihayet plakası seçimine gerek yoktur.
* PFT Series terminal blocks are double side closed, no need for an extra end plate usage.

PFT 2,5

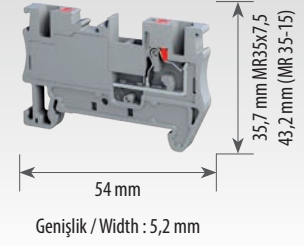

PFT 2,5		
8000298008		
100		
800 V / 24 A		
2,5		
0,5 - 2,5		
0,5 - 2,5		
0,5 - 2,5		
20-12 AWG		
12		
8		
3 / III / I		
Ürün Adı Product Name	Sipariş No Order No.	Adet Qty.
DR 35-7,5 S 2M	8015393407	40
DR 35-15 S 2M	8015393427	20
PS 1	8010197328	50
PCC 2,5/2	8013294523	100
PCC 2,5/3	8013294533	100
PCC 2,5/10	8013294503	10
MTG 5	8020389009	500
TBSL 22X20	8020384009	1
GM1	8014393008	50
GM2	8014393018	50

Renk Kodları / Color Codes								
800009900....	...0	...1	...2	...3	...4	...5	...6	...9

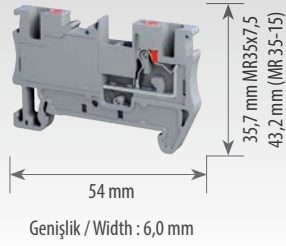
PFT 4**PFT 4**

8000298018

100

800 V / 32 A

4

1,5 - 4

1,5 - 4

1,5 - 4

20-10 AWG

12

8

3 / III / I

Ürün Adı Product Name	Sipariş No Order No.	Adet Qty.
DR 35-7,5 S 2M	8015393407	40
DR 35-15 S 2M	8015393427	20
PS 1	8010197328	50
PCC 4/2	8013294623	100
PCC 4/3	8013294633	100
PCC 4/10	8013294603	10
MTG 6	8020388009	500
TBSL 22X20	8020384009	1
GM1	8014393008	50
GM2	8014393018	50

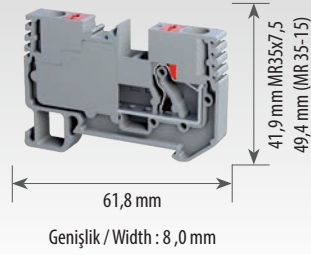
PFT 6**PFT 6**

8000298028

50

1000 V / 41 A

6

1,5 - 6

1,5 - 6

1,5 - 6

20-8 AWG

12

8

3 / III / I

Ürün Adı Product Name	Sipariş No Order No.	Adet Qty.
DR 35-7,5 S 2M	8015393407	40
DR 35-15 S 2M	8015393427	20
PS 1	8010197328	50
PCC 6/2	8013294723	50
PCC 6/3	8013294733	50
PCC 6/10	8013294703	10
MTG 8	8020386009	500
TBSL 22X20	8020384009	1
GM1	8014393008	50
GM2	8014393018	50

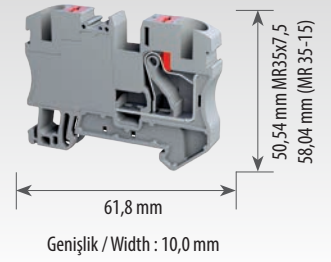
PFT 10**PFT 10**

8000298038

30

1000 V / 57 A

10

1,5 - 10

1,5 - 10

1,5 - 10

20-6 AWG

18

8

3 / III / I

Ürün Adı Product Name	Sipariş No Order No.	Adet Qty.
DR 35-7,5 S 2M	8015393407	40
DR 35-15 S 2M	8015393427	20
PS 1	8010197328	50
PCC 10/2	8013294823	10
PCC 10/3	8013294833	10
MTG 10	8020385009	250
TBSL 22X20	8020384009	1
GM1	8014393008	50
GM2	8014393018	50

* PFT Serisi klemenslerimiz iki tarafı kapalı tipte olduğundan, nihayet plakası seçimine gerek yoktur.

* PFT Series terminal blocks are double side closed, no need for an extra end plate usage.

Push-in Klemensleri Push-in Terminal Blocks

Topraklama Klemensleri Earth Terminal Blocks



Ürün Adı / Product Name
Sipariş No / Order No.
Paket Adeti / Packing Qty.
Anma Değerleri / Rated Values
IEC 60947-7-2
Bağlantı Bilgileri / Connection Information
Kesit / Cross-Section (mm²)
Tek Damarlı Kablo / Solid Conductor Cross-Section min mm²: (mm²)-(min-max)
Çok Damarlı Kablo / Stranded Conductor Cross-Section (mm²)-(min-max)
Çok Tellî Kablo / Flexible Conductor Cross-Section (mm²)-(min-max)
AWG
Açıklamalar / Descriptions
Kablo Soyma Uzunluğu / Insulation Stripping Length (mm)
Max. Sıkma Torku (N.m) / Max. Tightening Torque
Bağlantı Vidası / Screw Diameter
Darbe Gerilimi / Rated Impulse Voltage (Kv)
Kirlilik Derecesi / Gerilim Kategorisi / Malzeme Grubu / Pollution Degree / Voltage Category / Material Group
Aksesuarlar / Accessories
Montaj Rayı / Din Rail
Durdurucu / End Stopper
Klemens Etiketi / Marking Tags
Şerit Etiket / Strip Label
Grup Etiketi / Group Label

* PFT Serisi klemenslerimiz iki tarafı kapalı tipte olduğundan, nihayet plakası secimine gerek yoktur.
* PFT Series terminal blocks are double side closed, no need for an extra end plate usage.

PFT 2,5 E

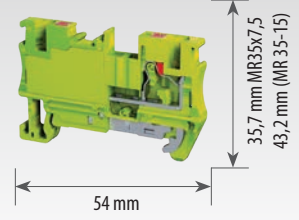

Genişlik / Width : 5,2 mm



PFT 2,5 E

8001298064

50

2,5

0,5 - 2,5

0,5 - 2,5

0,5 - 2,5

20-12 AWG

12

8

3 / III / I

Ürün Adı Product Name	Sipariş No Order No.	Adet Qty.
DR 35-7,5 S 2M	8015393407	40
DR 35-15 S 2M	8015393427	20
PS 1	8010197328	50
MTG 5	8020389009	500
TBSL 22X20	8020384009	1
GM1	8014393008	50
GM2	8014393018	50

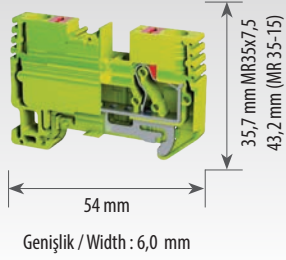
PFT 4 E**PFT 4 E**

8001298074

50

4

0,5 - 4

0,5 - 4

0,5 - 4

20-10 AWG

12

8

3 / III / I

Ürün Adı Product Name	Sipariş No Order No.	Adet Qty.
DR 35-7,5 S 2M	8015393407	40
DR 35-15 S 2M	8015393427	20
PS 1	8010197328	50
MTG 6	8020389009	500
TBSL 22X20	8020384009	1
GM1	8014393008	50
GM2	8014393018	50

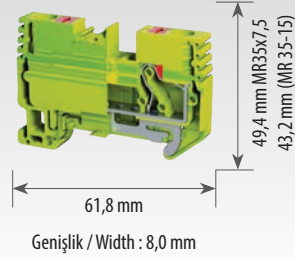
PFT 6 E**PFT 6 E**

8001298084

25

6

0,5 - 6

0,5 - 6

0,5 - 6

20-8 AWG

12

8

3 / III / I

Ürün Adı Product Name	Sipariş No Order No.	Adet Qty.
DR 35-7,5 S 2M	8015393407	40
DR 35-15 S 2M	8015393427	20
PS 1	8010197328	50
MTG 8	8020389009	500
TBSL 22X20	8020384009	1
GM1	8014393008	50
GM2	8014393018	50

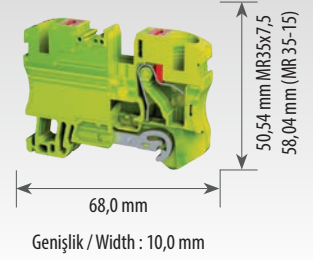
PFT 10 E**PFT 10 E**

8001298104

30

10

0,5 - 16

0,5 - 10

0,5 - 10

20-6 AWG

18

8

3 / III / I

Ürün Adı Product Name	Sipariş No Order No.	Adet Qty.
DR 35-7,5 S 2M	8015393407	40
DR 35-15 S 2M	8015393427	20
PS 1	8010197328	50
MTG 10	8020385009	250
TBSL 22X20	8020384009	1
GM1	8014393008	50
GM2	8014393018	50

* PFT Serisi klemenslerimiz iki tarafı kapalı tipte olduğundan, nihayet plakası seçimine gerek yoktur.

* PFT Series terminal blocks are double side closed, no need for an extra end plate usage.

Push-in Klemensleri Push-in Terminal Blocks

Çok Girişli ve Çıkışlı Klemensler
Multi - Entry and Multi - Level Terminal Blocks



Ürün Adı / Product Name	
Sipariş No / Order No.	
Paket Adeti / Packing Qty.	
Anma Değerleri / Rated Values	
IEC 60947-7-1 / IEC 60947-7-2 (PFT 2,5 2P+E)	
Bağlantı Bilgileri / Connection Information	
Kesit / Cross-Section (mm²)	
Tek Damarlı Kablo / Solid Conductor Cross-Section min mm²: (mm²)-(min-max)	
Çok Damarlı Kablo / Stranded Conductor Cross-Section (mm²)-(min-max)	
Çok Telli Kablo / Flexible Conductor Cross-Section (mm²)-(min-max)	
AWG	
Açıklamalar / Descriptions	
Kablo Soyma Uzunluğu / Insulation Stripping Length (mm)	
Max. Sıkma Torku (N.m) / Max. Tightening Torque	
Bağlantı Vidası / Screw Diameter	
Darbe Gerilimi / Rated Impulse Voltage (Kv)	
Kirlilik Derecesi / Gerilim Kategorisi / Malzeme Grubu / Pollution Degree / Voltage Category / Material Group	
Aksesuarlar / Accessories	
Montaj Rayı / Din Rail	
Durdurucu / End Stopper	
Üst Köprü / Cross Connection	
Klemens Etiketi / Marking Tags	
Şerit Etiket / Strip Label	
Grup Etiketi / Group Label	

* PFT Serisi klemenslerimiz iki tarafı kapalı tipte olduğundan, nihayet plakası seçimine gerek yoktur.
* PFT Series terminal blocks are double side closed, no need for an extra end plate usage.

PFT 2,5 1X2

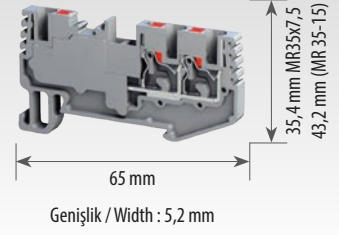

PFT 2,5 1X2		
8000298068		
40		
800 V / 24 A		
2,5		
0,5 - 2,5		
0,5 - 2,5		
0,5 - 2,5		
20-12 AWG		
12		
8		
3 / III / I		
Ürün Adı Product Name	Sipariş No Order No.	Adet Qty.
DR 35-7,5 S 2M	8015393407	40
DR 35-15 S 2M	8015393427	20
PS 1	8010197328	50
PCC 2,5/2	8013294523	100
PCC 2,5/3	8013294533	100
PCC 2,5/10	8013294503	10
MTG 5	8020389009	500
TBSL 22X20	8020384009	1
GM1	8014393008	50
GM2	8014393018	50

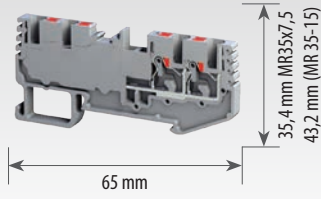
PFT 2,5 2X2

Genişlik / Width : 5,2 mm

**PFT 2,5 2X2**

8000298078

40

800 V / 24 A

2,5

0,5 - 2,5

0,5 - 2,5

0,5 - 2,5

20-12 AWG

12

8

3 / III / I

Ürün Adı Product Name	Sipariş No Order No.	Adet Qty.
DR 35-7,5 S 2M	8015393407	40
DR 35-15 S 2M	8015393427	20
PS 1	8010197328	50
PCC 2,5/2	8013294523	100
PCC 2,5/3	8013294533	100
PCC 2,5/10	8013294503	10
MTG 5	8020389009	500
TBSL 22X20	8020384009	1
GM1	8014393008	50
GM2	8014393018	50

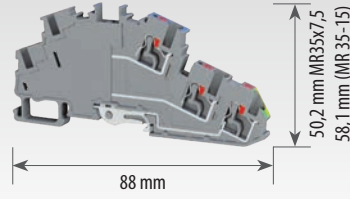
PFT 2,5 2P+E

Genişlik / Width : 5,2 mm

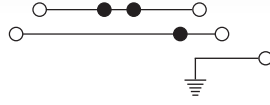
**PFT 2,5 2P+E**

8002298108

30

500 V / 24 A

2,5

0,5 - 2,5

0,5 - 2,5

0,5 - 2,5

20-12 AWG

12

8

3 / III / I

Ürün Adı Product Name	Sipariş No Order No.	Adet Qty.
DR 35-7,5 S 2M	8015393407	40
DR 35-15 S 2M	8015393427	20
PS 1	8010197328	50
PCC 2,5/2	8013294523	100
PCC 2,5/3	8013294533	100
PCC 2,5/10	8013294503	10
MTG 5	8020389009	500
TBSL 22X20	8020384009	1
GM1	8014393008	50
GM2	8014393018	50

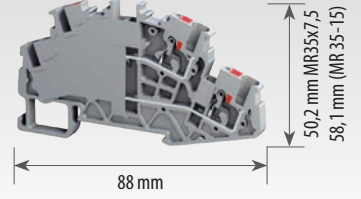
PFT 2,5 2P

Genişlik / Width : 5,2 mm

**PFT 2,5 2P**

8002298098

50

500 V / 24 A

2,5

0,5 - 2,5

0,5 - 2,5

0,5 - 2,5

20-12 AWG

12

8

3 / III / I

Ürün Adı Product Name	Sipariş No Order No.	Adet Qty.
DR 35-7,5 S 2M	8015393407	40
DR 35-15 S 2M	8015393427	20
PS 1	8010197328	50
PCC 2,5/2	8013294523	100
PCC 2,5/3	8013294533	100
PCC 2,5/10	8013294503	10
MTG 5	8020389009	500
TBSL 22X20	8020384009	1
GM1	8014393008	50
GM2	8014393018	50

* PFT Serisi klemenslerimiz iki tarafı kapalı tipte olduğundan, nihayet plakası seçimine gerek yoktur.

* PFT Series terminal blocks are double side closed, no need for an extra end plate usage.

Sıra Klemensleri

Terminal Strips

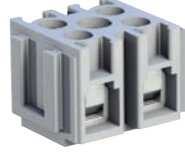

CSK 2,5



SRK 16/3



SRK 16/8



Ürün Adı Product Name	Sipariş No Order No.	Gerilim (V) Voltage (V)	Akım (A) Current (A)	Kesit (mm ²) Cross Section (mm ²)	Kutup Sayısı Number of Poles	Vida Clamping Screw	Tork (Nm) Torque (Nm)	Paket Adeti Packing Qty.
SRK 16/2	8006097008	400	24	2,5	2	M 5	2	96
SRK 16/3	8006097018	400	24	2,5	3	M 5	2	32
SRK 16/4	8006097028	400	24	2,5	4	M 5	2	48
SRK 16/5	8006097038	400	24	2,5	5	M 5	2	32
SRK 16/6	8006097048	400	24	2,5	6	M 5	2	30
SRK 16/8	8006097058	400	24	2,5	8	M 5	2	24
SRK 16/10	8006097068	400	24	2,5	10	M 5	2	16
SRK 16/12	8006097078	400	24	2,5	12	M 5	2	8
CSK 2,5	8006097108	500	24	2,5	2	M 2,5	0,4 - 0,6	100
CSK 6	8006097118	800	41	6	2	M 3,5	0,8 - 1,2	60

Durdurucular

End Bracket

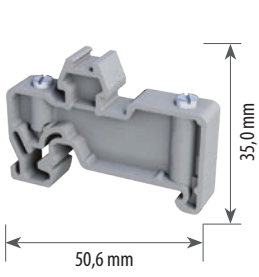

Genişlik / Width : 9,5 mm

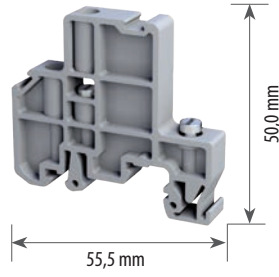

Genişlik / Width : 10,0 mm

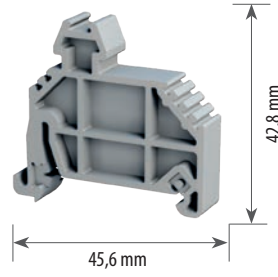

Genişlik / Width : 10,0 mm

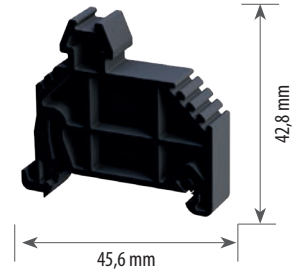

Genişlik / Width : 10,0 mm

Ürün Adı Product Name	SS 1
Sipariş No Order No.	8010097308
Montaj Fixing	Vidalı Screw Type
Renk Color	Gri Gray
Ray Rail	MR 35
Etiket Marker	MTG 5
Paket Adeti Packing Qty.	50

Ürün Adı Product Name	SS 2
Sipariş No Order No.	8010097318
Montaj Fixing	Vidalı Screw Type
Renk Color	Gri Gray
Ray Rail	MR 35 MR 32
Etiket Marker	MTG 5
Paket Adeti Packing Qty.	50

Ürün Adı Product Name	PS 1
Sipariş No Order No.	8010197328
Montaj Fixing	Push in Push in
Renk Color	Gri Gray
Ray Rail	MR 35
Etiket Marker	MTG 5
Paket Adeti Packing Qty.	50

Ürün Adı Product Name	PS 1
Sipariş No Order No.	8010197320
Montaj Fixing	Push in Push in
Renk Color	Siyah Black
Ray Rail	MR 35
Etiket Marker	MTG 5
Paket Adeti Packing Qty.	50

Grup Etiketi

Group Marker

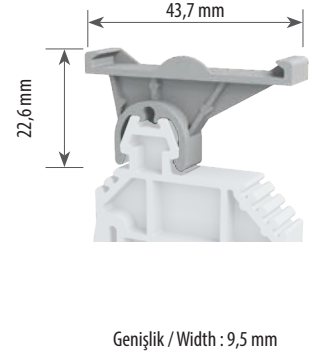
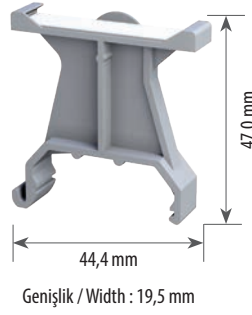
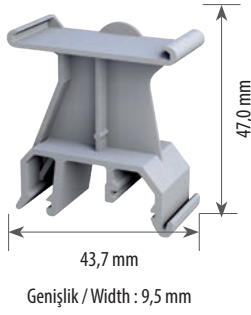

Ürün Adı Product Name	GM 1
Sipariş No Order No.	8014393008
Renk Color	Gri / Gray
Ray Rail	MR 35
Paket Adeti Packing Qty.	50

Ürün Adı Product Name	GM 2
Sipariş No Order No.	8014393018
Renk Color	Gri / Gray
Ray Rail	MR 32 - MR 35
Paket Adeti Packing Qty.	50

Ürün Adı Product Name	SL 1
Sipariş No Order No.	8012396008
Renk Color	Gri / Gray
Paket Adeti Packing Qty.	50

Etiket Şemsiyesi

Marker Holder



Ürün Adı Product Name	LHO
Sipariş No Order No.	8020390009
Etiket Marker	TBSL 22x20
Paket Adeti Packing Qty.	10

Nihayet Plakaları

End Plates

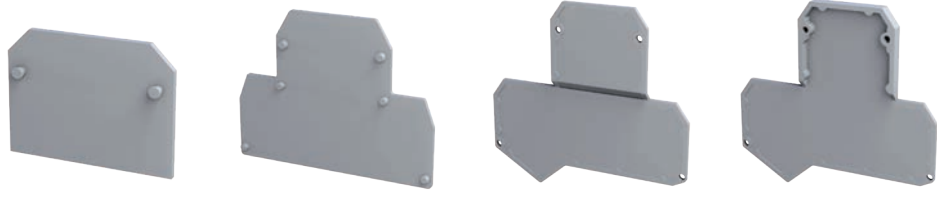

Ürün Adı Product Name	EPL TBL 2,5-10	EPL TBL 2,5-4 2P	EPL1 TBL 4 2P	EPL2 TBL 4 2P
Sipariş No Order No.	8012396118	8012396208	8012396218	8012396228
Renk Color	Gri / Gray	Gri / Gray	Gri / Gray	Gri / Gray
Kullanıldığı Klemens Used with	TBL 2,5, TBL 4, TBL 6 TBL 10	TBL 2,4-4 2P	TBL 4 2P	TBL 4 2P
Paket Adeti Packing Qty.	50	20	20	20



Ürün Adı Product Name	EPL TDS	EPL TDV	EPL TDY
Sipariş No Order No.	8012396018	8012396028	8012396038
Renk Color	Gri / Gray	Gri / Gray	Gri / Gray
Kullanıldığı Klemens Used with	TDS - C 6, TDS - V 6	TDV - C 6, TDS - V 6	TDY - C 6, TDY - C 6-1
Paket Adeti Packing Qty.	50	50	50

Koruma Kapakları

Isolation Covers

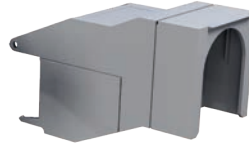

Ürün Adı Product Name	C-TBB 70-95-150	C-TBB 240
Sipariş No Order No.	8012396608	8012396618
Renk Color	Gri / Gray	Gri / Gray
Kullanıldığı Klemens Used with	TBB 70-95-150	TBB 240
Paket Adeti Packing Qty.	8	10

Ayrma Plakaları

Partition Plates



Ürün Adı Product Name	PR TBL 2,5-10	PR TBL 4 2P	SPR 2,5-10
Sipariş No Order No.	8012396408	8012396508	8012396528
	8012396406 ●		
Renk Color	Gri / Gray	Gri / Gray	Gri / Gray
Kullanıldığı Klemens Used with	TBL 4, TBL 6, TBL 10	TBL 4 2P	TBL 2,5, TBL 4, TBL 6, TBL 10
Paket Adeti Packing Qty.	50	20	100

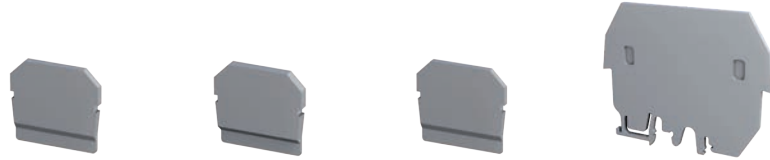

Ürün Adı Product Name	SPR 16-35	SPR 50	SPR TBL 4 2P	GPR
Sipariş No Order No.	8012396538	8012396548	8012396558	8012396568
				8012396566 ●
Renk Color	Gri / Gray	Gri / Gray	Gri / Gray	Gri / Gray
Kullanıldığı Klemens Used with	TBL 16, TBL 35	TBL 50	TBL 4 2P	TBL 16, TBL 35, TBL 50
Paket Adeti Packing Qty.	50	50	100	20

Test Fişleri

Test Sockets



Sipariş No Order No.	Ürün Adı Product Name	Birlikte Kullanıldığı Klemens Used in Terminal	Renk Color	Amb. Mik. Pack. Qty (Adet/Pcs.)
8014393106	TST-I 1	TBL 6, TBL 10, TDT-C, TDT-V, TDS-C, TDS-V	Mavi / Blue	50
8014393104	TST-I 1	TBL 6, TBL 10, TDT-C, TDT-V, TDS-C, TDS-V	Sarı / Yellow	50
8014393108	TST-I 1	TBL 6, TBL 10, TDT-C, TDT-V, TDS-C, TDS-V	Gri / Gray	50
8014393102	TST-I 1	TBL 6, TBL 10, TDT-C, TDT-V, TDS-C, TDS-V	Kırmızı / Red	50
8014393100	TST-I 1	TBL 6, TBL 10, TDT-C, TDT-V, TDS-C, TDS-V	Siyah / Black	50
8014393227	TST 1	TBL 2,5, TBL 4, TBL 2,5-4 2P, TBL 4 2P, TBL 2,5 3P		50
8014393237	TST 2	TBL 10		50
8014393247	TST 3	TBL 16		50
8014393257	TST 4	TBL 25, TBL 35		50

Tarak Köprüler

Comb Connector



Sipariş No Order No.	Ürün Adı Product Name	Birlikte Kullanıldığı Klemens Used in Terminal	Pin Pole	Kesit (mm ²) Cross Section (mm ²)	Renk Color	Amb. Mik. Pack. Qty (Adet/Pcs.)
8013094323	TCC 4/2	TBL 4	2	4	Kırmızı / Red	50
8013094333	TCC 4/3	TBL 4	3	4	Kırmızı / Red	50
8013094303	TCC 4/10	TBL 4	10	4	Kırmızı / Red	10

Vidalı Üst Köprüler

Cross Connections

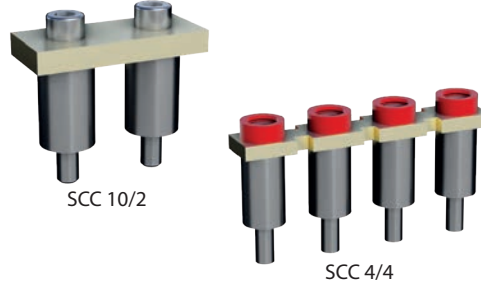

Sipariş No Order No.	Ürün Adı Product Name	Birlikte Kullanıldığı Klemens Used in Terminal	Kutup Sayısı Pole	Kesit (mm ²) Cross Section (mm ²)	Amb. Mik. Pack. Qty (Adet/Pcs.)
8013095023	SCC 2,5/2	TBL 2,5, TBL 2,5-4 2P	2	2,5	50
8013095033	SCC 2,5/3	TBL 2,5, TBL 2,5-4 2P	3	2,5	50
8013095003	SCC 2,5/10	TBL 2,5, TBL 2,5-4 2P	10	2,5	10
8013095123	SCC 4/2	TBL 4, TBL 4 2P	2	4	50
8013095133	SCC 4/3	TBL 4, TBL 4 2P	3	4	50
8013095103	SCC 4/10	TBL 4, TBL 4 2P	10	4	10
8013095223	SCC 6/2	TBL 6	2	6	50
8013095233	SCC 6/3	TBL 6	3	6	50
8013095203	SCC 6/10	TBL 6	10	6	10
8013095323	SCC 10/2	TBL 10	2	6	50
8013095333	SCC 10/3	TBL 10	3	10	50
8013095303	SCC 10/10	TBL 10	10	10	10
8013095423	SCC 16/2	TBL 16	2	10	20
8013095433	SCC 16/3	TBL 16	3	16	20
8013095403	SCC 16/10	TBL 16	10	16	10
8013095523	SCC 25/2	TBL 25	2	16	20
8013095533	SCC 25/3	TBL 25	3	25	20
8013095503	SCC 25/10	TBL 25	10	25	10
8013095623	SCC 35/2	TBL 35	2	25	20
8013095633	SCC 35/3	TBL 35	3	35	20
8013095603	SCC 35/10	TBL 35	10	35	10
8013095723	SCC 50/2	TBL 50	2	50	10
8013095733	SCC 50/3	TBL 50	3	50	10
8013095823	SCC 70/2	TBL 70	2	70	10
8013095833	SCC 70/3	TBL 70	3	70	10
8013095923	SCC 95/2	TBL 95	2	95	10
8013095933	SCC 95/3	TBL 95	3	95	10
8013094023	SCC 150/2	TBL 150	2	150	10
8013094123	SCC 4/2 TBL 4 2P	TBL 4 2P	2	4	50
8013094133	SCC 4/3 TBL 4 2P	TBL 4 2P	3	4	50
8013094163	SCC 4/6 TBL 4 2P	TBL 4 2P	6	4	20
8013094103	SCC 4/10 TBL 4 2P	TBL 4 2P	10	4	10

Push-in Üst Köprüler

Push-in Cross Connections

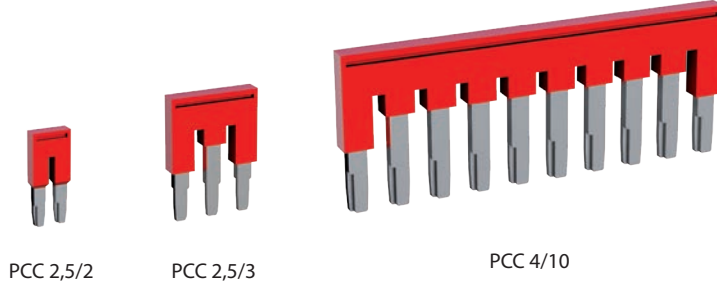

PCC 2,5/2

PCC 2,5/3

PCC 4/10

Sipariş No Order No.	Ürün Adı Product Name	Birlikte Kullanıldığı Klemens Used in Terminal	Kutup Sayısı Pole	Kesit (mm ²) Cross Section (mm ²)	Amb. Mik. Pack. Qty (Adet/Pcs.)
8013294523	PCC 2,5/2	PFT 2,5, PFT 2,5 1x2, PFT 2,5 2x2, PFT 2,5 2P, PFT 2,5 E	2	2,5	100
8013294533	PCC 2,5/3	PFT 2,5, PFT 2,5 1x2, PFT 2,5 2x2, PFT 2,5 2P, PFT 2,5 E	3	2,5	100
8013294503	PCC 2,5/10	PFT 2,5, PFT 2,5 1x2, PFT 2,5 2x2, PFT 2,5 2P, PFT 2,5 E	10	2,5	10
8013294623	PCC 4/2	PFT 4	2	4	100
8013294633	PCC 4/3	PFT 4	3	4	100
8013294603	PCC 4/10	PFT 4	10	4	10
8013294723	PCC 6/2	PFT 6	2	6	50
8013294733	PCC 6/3	PFT 6	3	6	50
8013294703	PCC 6/10	PFT 6	10	6	10
8013294823	PCC 10/2	PFT 10	2	10	10
8013294833	PCC 10/3	PFT 10	3	10	10

Kayar Köprüler

Sliding Connector



SLC 2

SLC-R 4

Sipariş No Order No.	Ürün Adı Product Name	Birlikte Kullanıldığı Klemens Used in Terminal	Kutup Sayısı Pole	Kesit (mm ²) Cross Section (mm ²)	Amb. Mik. Pack. Qty (Adet/Pcs.)
8013394923	SLC 2	TDT-C 6, TDT-V 6, TDS-C 6, TDS-V 6	2	6	50
8013394933	SLC 3	TDT-C 6, TDT-V 6, TDS-C 6, TDS-V 6	3	6	50
8013394943	SLC 4	TDT-C 6, TDT-V 6, TDS-C 6, TDS-V 6	4	6	50
8014393307	SLC-R 2	TDY-C 6	2	6	50
8014393317	SLC-R 3	TDY-C 6	3	6	50
8014393327	SLC-R 4	TDY-C 6	4	6	50

Klemens Etiketleri

Marking Tags

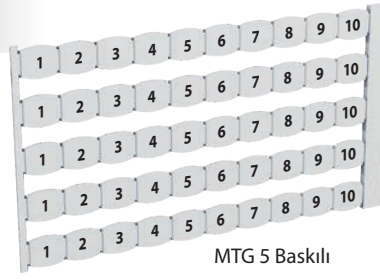

MTG 5 Baskılı

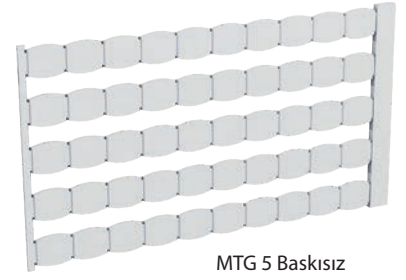

MTG 5 Baskısız

Ürün Kodu Product Code	Ürün Adı Product Name	Açıklama Description	Amb. Mik. Pack. Qty (Etiket - Tags / Pcs.)
8020389019	MTG 5 Baskılı	Baskılı / Printed	500
8020389009	MTG 5 Baskısız	Boş / Empty	500
8020389029	MTG 5 (1-10)	1-10	500
8020389039	MTG 5 (11-20)	11-20	500
8020389049	MTG 5 (21-30)	21-30	500
8020389059	MTG 5 (31-40)	31-40	500
8020389069	MTG 5 (41-50)	41-50	500
8020389079	MTG 5 (51-60)	51-60	500
8020389089	MTG 5 (61-70)	61-70	500
8020389099	MTG 5 (71-80)	71-80	500
8020389109	MTG 5 (81-90)	81-90	500
8020389119	MTG 5 (91-100)	91-100	500
8020389129	MTG 5 (1-50)	1-50	500
8020389139	MTG 5 (51-100)	51-100	500
8020389149	MTG 5 (101-150)	101-150	500
8020389159	MTG 5 (151-200)	151-200	500
8020389169	MTG 5 (201-250)	201-250	500
8020389179	MTG 5 (251-300)	251-300	500
8020389189	MTG 5 (301-350)	301-350	500
8020389199	MTG 5 (351-400)	351-400	500
8020389209	MTG 5 (401-450)	401-450	500
8020389219	MTG 5 (451-500)	451-500	500
8020388019	MTG 6 Baskılı	Baskılı / Printed	500
8020388009	MTG 6 Baskısız	Boş / Empty	500
8020388839	MTG 6 (L1, L2, L3, N)	L1, L2, L3, N	500
8020388309	MTG 6 (0)	0	500
8020388319	MTG 6 (1)	1	500
8020388599	MTG 6 (5)	5	500
8020388329	MTG 6 (2)	2	500
8020388339	MTG 6 (3)	3	500
8020388349	MTG 6 (4)	4	500
8020388359	MTG 6 (5)	5	500
8020388369	MTG 6 (6)	6	500
8020388379	MTG 6 (7)	7	500
8020388389	MTG 6 (8)	8	500
8020388399	MTG 6 (9)	9	500
8020388409	MTG 6 (10)	10	500
8020388029	MTG 6 (0-9)	0-9	500
8020388039	MTG 6 (1-10)	1-10	500
8020388879	MTG 6 (11-20)	11-20	500
8020388889	MTG 6 (21-30)	21-30	500
8020388899	MTG 6 (31-40)	31-40	500
8020388909	MTG 6 (41-50)	41-50	500
8020388919	MTG 6 (51-60)	51-60	500
8020388929	MTG 6 (61-70)	61-70	500
8020388939	MTG 6 (71-80)	71-80	500
8020388949	MTG 6 (81-90)	81-90	500
8020388959	MTG 6 (91-100)	91-100	500

Klemens Etiketleri

Marking Tags

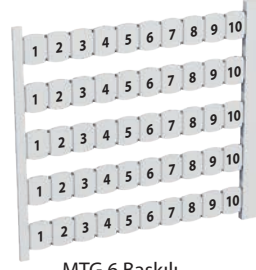

MTG 6 Baskılı



MTG 6 Baskısız

Ürün Kodu Product Code	Ürün Adı Product Name	Açıklama Description	Amb. Mik. Pack. Qty (Etiket - Tags / Pcs.)
8020388049	MTG 6 (1-50)	1-50	500
8020388059	MTG 6 (51-100)	51-100	500
8020388069	MTG 6 (101-150)	101-150	500
8020388079	MTG 6 (151-200)	151-200	500
8020388089	MTG 6 (201-250)	201-250	500
8020388099	MTG 6 (251-300)	251-300	500
8020388109	MTG 6 (301-350)	301-350	500
8020388119	MTG 6 (351-400)	351-400	500
8020388129	MTG 6 (401-450)	401-450	500
8020388139	MTG 6 (451-500)	451-500	500
8020388149	MTG 6 (501-550)	501-550	500
8020388159	MTG 6 (551-600)	551-600	500
8020388169	MTG 6 (601-650)	601-650	500
8020388179	MTG 6 (651-700)	651-700	500
8020388189	MTG 6 (701-750)	701-750	500
8020388199	MTG 6 (751-800)	751-800	500
8020388209	MTG 6 (801-850)	801-850	500
8020388219	MTG 6 (851-900)	851-900	500
8020388229	MTG 6 (901-950)	901-950	500
8020388239	MTG 6 (951-1000)	951-1000	500
8020388859	MTG 6 (RSTN)	RSTN	500
8020388779	MTG 6 (+)	+	500
8020388789	MTG 6 (-)	-	500
8020388429	MTG 6 (B)	B	500
8020388849	MTG 6 (PE)	PE	500
8020388459	MTG 6 (E)	E	500
8020388529	MTG 6 (L)	L	500
8020388549	MTG 6 (N)	N	500
8020388659	MTG 6 (Y)	Y	500
8020388589	MTG 6 (R)	R	500
8020388829	MTG 6 (L1, L2, L3)	L1, L2, L3	500
8020388799	MTG 6 (L1)	L1	500
8020388809	MTG 6 (L2)	L2	500
8020388499	MTG 6 (I)	I	500
8020388449	MTG 6 (D)	D	500
8020388519	MTG 6 (K)	K	500
8020388469	MTG 6 (F)	F	500
8020388419	MTG 6 (A)	A	500
8020388539	MTG 6 (M)	M	500
8020388569	MTG 6 (P)	P	500
8020388679	MTG 6 (X1)	X1	500
8020388689	MTG 6 (X2)	X2	500
8020388699	MTG 6 (X3)	X3	500
8020388709	MTG 6 (X4)	X4	500
8020388719	MTG 6 (X5)	X5	500
8020388729	MTG 6 (X6)	X6	500
8020388739	MTG 6 (X7)	X7	500
8020388749	MTG 6 (X8)	X8	500

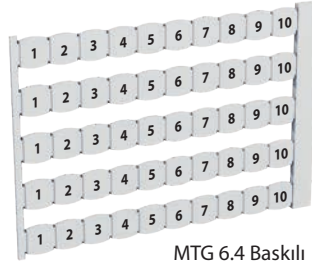

MTG 6.4 Baskılı

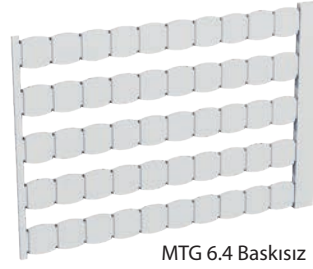

MTG 6.4 Baskısız

Ürün Kodu Product Code	Ürün Adı Product Name	Açıklama Description	Amb. Mik. Pack. Qty (Etiket - Tags / Pcs.)
8020388759	MTG 6 (X9)	X9	500
8020388769	MTG 6 (X10)	X10	500
8020388439	MTG 6 (C)	C	500
8020388629	MTG 6 (V)	V	500
8020388479	MTG 6 (G)	G	500
8020388489	MTG 6 (H)	H	500
8020388819	MTG 6 (L3)	L3	500
8020388869	MTG 6 (MP)	MP	500
8020388609	MTG 6 (T)	T	500
8020387019	MTG 6,4 Baskılı	Baskılı / Printed	500
8020387009	MTG 6,4 Baskısız	Boş / Empty	500
8020387309	MTG 6,4 (1)	1	500
8020387319	MTG 6,4 (2)	2	500
8020387329	MTG 6,4 (3)	3	500
8020387339	MTG 6,4 (4)	4	500
8020387349	MTG 6,4 (5)	5	500
8020387359	MTG 6,4 (6)	6	500
8020387369	MTG 6,4 (7)	7	500
8020387379	MTG 6,4 (8)	8	500
8020387389	MTG 6,4 (9)	9	500
8020387399	MTG 6,4 (10)	10	500
8020387029	MTG 6,4 (0-9)	0-9	500
8020387039	MTG 6,4 (1-50)	1-50	500
8020387049	MTG 6,4 (51-100)	51-100	500
8020387059	MTG 6,4 (101-150)	101-150	500
8020387069	MTG 6,4 (151-200)	151-200	500
8020387079	MTG 6,4 (201-250)	201-250	500
8020387089	MTG 6,4 (251-300)	251-300	500
8020387099	MTG 6,4 (301-350)	301-350	500
8020387109	MTG 6,4 (351-400)	351-400	500
8020387119	MTG 6,4 (401-450)	401-450	500
8020387129	MTG 6,4 (451-500)	451-500	500
8020387139	MTG 6,4 (501-550)	501-550	500
8020387149	MTG 6,4 (551-600)	551-600	500
8020387159	MTG 6,4 (601-650)	601-650	500
8020387169	MTG 6,4 (651-700)	651-700	500
8020387179	MTG 6,4 (701-750)	701-750	500
8020387189	MTG 6,4 (751-800)	751-800	500
8020387199	MTG 6,4 (801-850)	801-850	500
8020387209	MTG 6,4 (851-900)	851-900	500
8020387219	MTG 6,4 (901-950)	901-950	500
8020387229	MTG 6,4 (951-1000)	951-1000	500
8020387239	MTG 6,4 (1001-1050)	1001-1050	500
8020387249	MTG 6,4 (1051-1100)	1051-1100	500
8020386019	MTG 8 Baskılı	Baskılı / Printed	500
8020386009	MTG 8 Baskısız	Boş / Empty	500
8020386199	MTG 8 (0)	0	500
8020386209	MTG 8 (1)	1	500

Klemens Etiketleri

Marking Tags

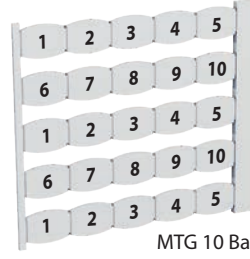

MTG 10 Baskılı



MTG 10 Baskısız

Ürün Kodu Product Code	Ürün Adı Product Name	Açıklama Description	Amb. Mik. Pack. Qty (Etiket - Tags / Pcs.)
8020386219	MTG 8 (2)	2	500
8020386229	MTG 8 (3)	3	500
8020386239	MTG 8 (4)	4	500
8020386249	MTG 8 (5)	5	500
8020386259	MTG 8 (6)	6	500
8020386269	MTG 8 (7)	7	500
8020386279	MTG 8 (8)	8	500
8020386289	MTG 8 (9)	9	500
8020386299	MTG 8 (10)	10	500
8020386309	MTG 8 (0-9)	0-9	500
8020386319	MTG 8 (1-10)	1-10	500
8020386029	MTG 8 (1-50)	1-50	500
8020386039	MTG 8 (51-100)	51-100	500
8020386049	MTG 8 (101-150)	101-150	500
8020386059	MTG 8 (151-200)	151-200	500
8020386069	MTG 8 (201-250)	201-250	500
8020386079	MTG 8 (251-300)	251-300	500
8020386089	MTG 8 (301-350)	301-350	500
8020386099	MTG 8 (351-400)	351-400	500
8020386109	MTG 8 (401-450)	401-450	500
8020386119	MTG 8 (451-500)	451-500	500
8020386169	MTG 8 (701-750)	701-750	500
8020386189	MTG 8 (801-850)	801-850	500
8020386329	MTG 8 (+)	+	500
8020386339	MTG 8 (-)	-	500
8020386349	MTG 8 (PE)	PE	500
8020386359	MTG 8 (L)	L	500
8020386369	MTG 8 (N)	N	500
8020386379	MTG 8 (L1, L2, L3)	L1, L2, L3	500
8020386389	MTG 8 (L1)	L1	500
8020386399	MTG 8 (L2)	L2	500
8020386409	MTG 8 (L3)	L3	500
8020385019	MTG 10 Baskılı	Baskılı / Printed	250
8020385009	MTG 10 Baskısız	Boş / Empty	250
8020385029	MTG 10 (1)	1	250
8020385039	MTG 10 (2)	2	250
8020385049	MTG 10 (3)	3	250
8020385059	MTG 10 (4)	4	250
8020385069	MTG 10 (5)	5	250
8020385079	MTG 10 (6)	6	250
8020385089	MTG 10 (7)	7	250
8020385099	MTG 10 (8)	8	250
8020385109	MTG 10 (9)	9	250
8020385119	MTG 10 (10)	10	250
8020385129	MTG 10 (RSTN)	RSTN	250
8020385139	MTG 10 (L1)	L1	250
8020385149	MTG 10 (L2)	L2	250
8020385159	MTG 10 (L3)	L3	250

Montaj Rayları

Mounting Rails

Elektrolitik beyaz krom kaplanmış galvaniz çelik malzeme
Electrolytic white chromated & galvanized steel material
EN 50022 EN 50035 IEC 60715

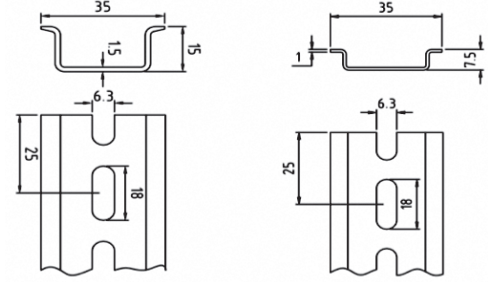

Ürün Kodu Product Code	Ürün Adı Product Name	Ölçüler / Dimensions (mm)			Açıklama Explanation	Birim Uzunluk Unit Length (m)	Ambalaj Miktarı Packing Qty (metre/meter)
		W	H	D			
8015393407	DR 35-7,5 S 2M	35	7,5	1	Delikli Din Normu Ray / Slotted Din Rail	2	40
8015393427	DR 35-15 S 2M	35	15	1,5	Delikli Din Normu Ray / Slotted Din Rail	2	20

Eko Seri Montaj Rayları

Economical Range Mounting Rails

Ürün Kodu Product Code	Ürün Adı Product Name	Ölçüler / Dimensions (mm)			Açıklama Explanation	Birim Uzunluk Unit Length (m)	Ambalaj Miktarı Packing Qty (metre/meter)
		W	H	D			
8015393447	DR 35-7,5 E 2M	35	7,5	0,9	Delikli Ray / Slotted Rail	2	40

Ray Taşıyıcılar

Rail Supports

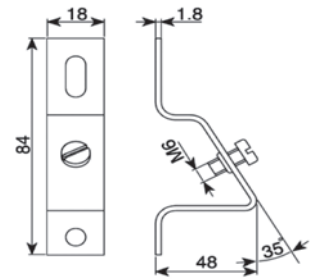

Ürün Kodu Product Code	Ürün Adı Product Name	Açıklama Explanation	Delik Çapı Dia. Hole	Ambalaj Miktarı Packing Qty (Adet/pcs.)
8015393507	ART - M6	35° Açılı Ray Taşıyıcı / 35° Angeled Rail Support	M6	50

Kanal Kesme Makası

Wiring Duct Cutter



WDC 125

Ürün Kodu Product Code	Ürün Adı Product Name	Açıklama Explanation	Ambalaj Miktarı Packing Qty (Adet/pcs.)
8019391300	WDC 125	125 mm genişliğe kadar kablo kanalları için Düz kesim tezgah üstü makas. Flat-cut Table-top type cutter up to 120 mm duct width	1

Ray Kesme Makası

Din Rail Cutters



DRC 2W8R

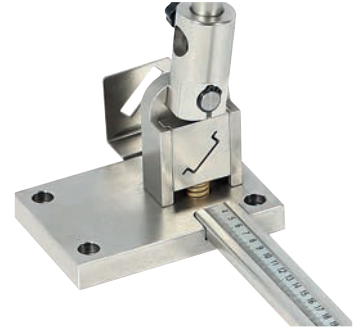

DRC 1W

Ürün Kodu Product Code	Ürün Adı Product Name	Açıklama Explanation	Ambalaj Miktarı Packing Qty (Adet/pcs.)
8015393557	DRC 1W	35x7.5 raya uygun, 1.5 mm kalınlığa kadar kesim, 1 gözlü tezgah üstü makas. 1 way table-top type cutter for 35x7.5 Din Rail, up to 1.5 mm thickness	1
8015393567	DRC 2W8R	35x7.5, 35x15 raya ve 8 mm Tij kesimine uygun, 3 gözlü tezgah üstü makas. 3 way table-top type cutter for 35x7.5, 35x15 Din Rails and 8 mm Rod	1

Pano Tipi Delikli Kablo Kanalları

Panel Type Slotted Wiring Ducts

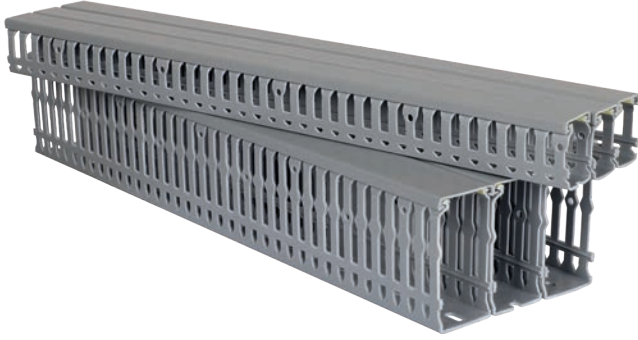

Ürün Kodu Product Code	Ürün Adı Product Name	Ölçüler / Dimensions (mm)		Renk Color	Ambalaj Miktarı Packing Qty (metre/meter)
		W	H		
8019391008	SWD 25x40 Pano Tipi Kablo Kanalı / Panel Type Slotted Wiring Ducts	25	40	Gri / Gray	60
8019391018	SWD 25x60 Pano Tipi Kablo Kanalı / Panel Type Slotted Wiring Ducts	25	60	Gri / Gray	40
8019391028	SWD 40x40 Pano Tipi Kablo Kanalı / Panel Type Slotted Wiring Ducts	40	40	Gri / Gray	40
8019391038	SWD 40x60 Pano Tipi Kablo Kanalı / Panel Type Slotted Wiring Ducts	40	60	Gri / Gray	36
8019391048	SWD 40x80 Pano Tipi Kablo Kanalı / Panel Type Slotted Wiring Ducts	40	80	Gri / Gray	28
8019391058	SWD 60x40 Pano Tipi Kablo Kanalı / Panel Type Slotted Wiring Ducts	60	40	Gri / Gray	32
8019391068	SWD 60x60 Pano Tipi Kablo Kanalı / Panel Type Slotted Wiring Ducts	60	60	Gri / Gray	24
8019391078	SWD 60x80 Pano Tipi Kablo Kanalı / Panel Type Slotted Wiring Ducts	60	80	Gri / Gray	16
8019391088	SWD 80x60 Pano Tipi Kablo Kanalı / Panel Type Slotted Wiring Ducts	80	60	Gri / Gray	20
8019391098	SWD 80x80 Pano Tipi Kablo Kanalı / Panel Type Slotted Wiring Ducts	80	80	Gri / Gray	16
8019391118	SWD 100x60 Pano Tipi Kablo Kanalı / Panel Type Slotted Wiring Ducts	100	60	Gri / Gray	12
8019391128	SWD 100x80 Pano Tipi Kablo Kanalı / Panel Type Slotted Wiring Ducts	100	80	Gri / Gray	8
8019391138	SWD 100x100 Pano Tipi Kablo Kanalı / Panel Type Slotted Wiring Ducts	100	100	Gri / Gray	8

Kablo Kanal Kapakları

Wiring Duct Covers



* Sarı renkli yumuşak PVC bölüm montaj esnasında elleri korurken, kanal kapağının daha sağlam tutmasını sağlar.
Soft and yellow PVC strip is protecting assembler hands from accidents and ensures a strong cover performance.

* Tırnaklardaki ilave delikler hem kolay kablolamada hem de kanal içi kablo seviye ayarlamasında yardımcı olur.
Additional holes in duct fingers assist for making different cable levels and as easy cable assembly.

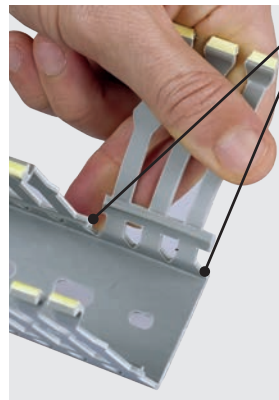

* Tırnak dipleri ve yan duvar köşesindeki 2 ayrı noktadan belirlenmiş kırılma özelliği bulunmaktadır.
There are 2 designated breaking lines in finger endpoints and 1 in duct sidewall corners.

Ürün Kodu Product Code	Ürün Adı Product Name	En Width (mm.)	Boy Length (m.)	Renk Color	Ambalaj Miktarı Packing Qty (metre/meter)
8019391208	SWC 25 Kapak / Wiring Duct Covers	20	2	Gri / Gray	40
8019391218	SWC 40 Kapak / Wiring Duct Covers	40	2	Gri / Gray	40
8019391228	SWC 60 Kapak / Wiring Duct Covers	60	2	Gri / Gray	40
8019391238	SWC 80 Kapak / Wiring Duct Covers	80	2	Gri / Gray	20
8019391248	SWC 100 Kapak / Wiring Duct Covers	100	2	Gri / Gray	20

Pano Tipi Delikli Kablo Kanalları Teknik Bilgiler

Panel Type Slotted Wiring Ducts Technical Information

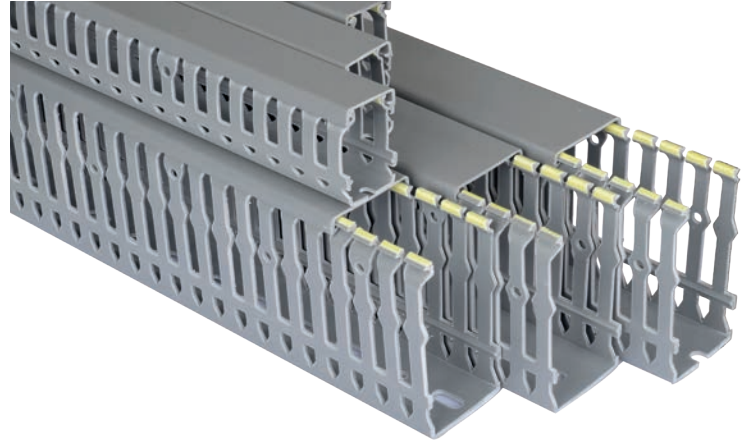

Ürün Kodu Product Code	Ürün Adı Product Name	Ölçüler / Dimensions (mm)						Ölçülmüş Toplam Kesit Measured Total Cross Sec. (mm ²)	İletken Dolum Kapasitesi (%60 oran için) Wire Filling Capacity (for 60% ratio)		
		W	H	E	F	G	Ø		2,5 mm ²	1,5 mm ²	1,0 mm ²
8019391008	SWD 25x40	25	40	6,5	5,9	12,8	4,5	820	35	51	78
8019391018	SWD 25x60	25	60	6,5	6	15,7	4,5	1.190	57	83	112
8019391028	SWD 40x40	40	40	6,5	5,9	12,8	4,5	1.360	65	94	129
8019391038	SWD 40x60	40	60	6,5	6	15,7	4,5	2.040	98	141	192
8019391048	SWD 40x80	40	80	6,5	6	19,8	4,5	2.700	130	187	255
8019391058	SWD 60x40	60	40	6,5	5,9	12,8	4,5	1.970	95	134	188
8019391068	SWD 60x60	60	60	6,5	6	15,7	4,5	3.080	148	214	291
8019391078	SWD 60x80	60	80	6,5	6	19,8	4,5	4.140	200	289	392
8019391088	SWD 80x60	80	60	6,5	6	15,7	4,5	4.150	200	288	391
8019391098	SWD 80x80	80	80	6,5	6	19,8	4,5	5.660	272	393	534
8019391118	SWD 100x60	100	60	6,5	6	15,7	4,5	5.250	254	364	491
8019391128	SWD 100x80	100	80	6,5	6	19,8	4,5	7.606	255	418	702
8019391138	SWD 100x100	100	100	6,5	6	19,8	4,5	8.920	430	619	812

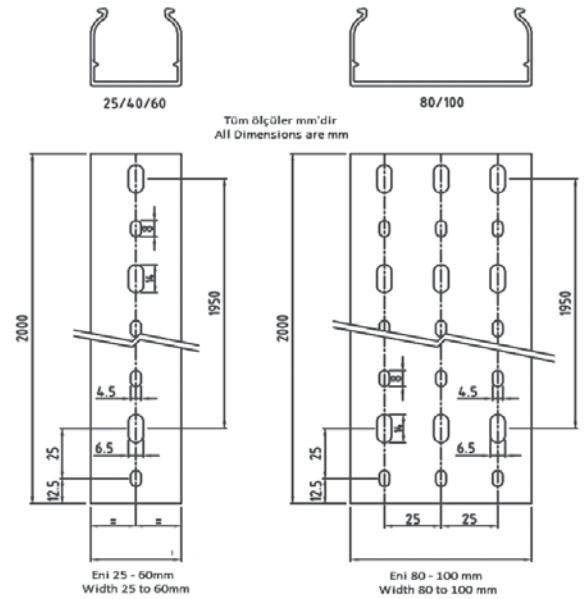
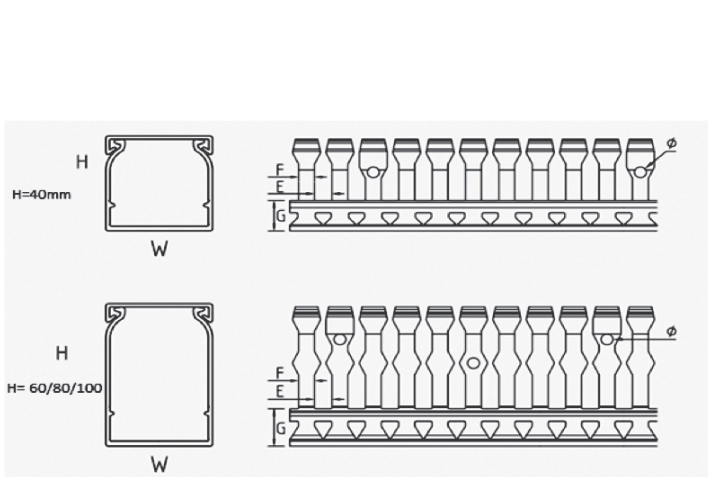

• Kanallar ve kapaklar 2 mt. lik boyda kesilmiş ve paketlenmiştir.

• Wiring ducts and covers are cut and packed in 2 m length.

Markalama Sistemleri

Marking Systems



Termal Transfer Yazıcı

Thermal Transfer Printer

Ürün Kodu Product Code	Ürün Adı Product Name	Amb. Mik. Pack. Qty. (Ad./Pcs.)
8030129000	TBL TP2 Termal Yazıcı / Thermal Printer	1

Ribonlar

Ribbons



Ürün Kodu Product Code	Ürün Adı Product Name	İç Çap Inner Diameter (mm)	Ölçüler Dimensions (mmxm)	Renk Color	Amb. Mik. Pack. Qty. (Ad./Pcs.)
8030129110	RR Ribbon 55x90	12,7 (½ inch)	55x90	Siyah / Black	1
8030129120	RR Ribbon 50x300	25,4 (1 inch)	50x300	Siyah / Black	1
8030129130	RR Ribbon 110x300	25,4 (1 inch)	110x300	Siyah / Black	1

Klemensler için Şerit Etiket

Terminal Blocks Strip Label

Ürün Kodu Product Code	Ürün Adı Product Name	Ölçüler Dimensions (mmxm)	Renk Color	Rulo Etiket Adedi Labels per Roll	Amb. Mik. Pack. Qty. (Ad./Pcs.)
8020384009	TBSL 22x20	22x20	Beyaz White	2 adet Şerit Etiket 2 pcs. of Strip Label	1
8020384011	TBSL 5,15x5	25,75x20	Beyaz White	5 adet Şerit Etiket 5 pcs. of Strip Label	1



TBSL 22x20

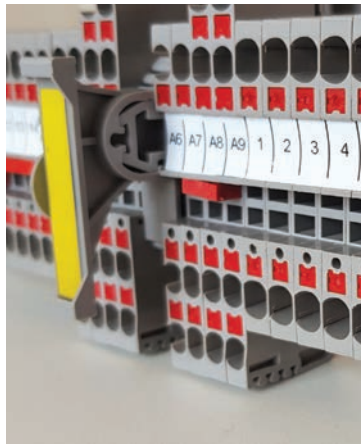

Kablo İşaretleme Plakaları (Şeffaf Tüpler için)

Cable Marking Plates (for Transparent Sleeves)

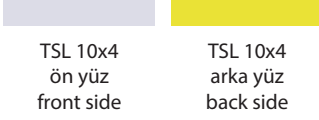

Ürün Kodu Product Code	Ürün Adı Product Name	Yazım Alanı Print Area (mm)	Açıklama Explanation	Amb. Mik. Pack. Qty. (Ad./Pcs.)
8021340004	TSL 10x4 Sarı - Beyaz / Yellow - White	10 x 4	Katlamalı Folded	3.000
8021340104	TSL 12x4 Sarı - Beyaz / Yellow - White	12 x 4	Katlamalı Folded	3.000
8021340014	TSL 15x4 Sarı - Beyaz / Yellow - White	15 x 4	Katlamalı Folded	3.000
8021340024	TSL 20x4 Sarı - Beyaz / Yellow - White	20 x 4	Katlamalı Folded	3.000
8021340034	TSL 30x4 Sarı - Beyaz / Yellow - White	30 x 4	Katlamalı Folded	3.000

Şeffaf Tüpler

Transparent Sleeves - Closed / Insertion Type



TS 10 1,5-2,5



TS 10 2,5-4,0



TS 10 6,0-10



TS 10 16-25

Ürün Kodu Product Code	Ürün Adı Product Name	Uzunluk Length (mm)	Renk Color	İletken Kesit Cond. Cross Sec. (mm ²)	Amb. Mik. Pack. Qty. (Ad./Pcs.)
8021343019	TS 10 1,5-2,5	10	Şeffaf / Transparent	1,5 - 2,5	500
8021343029	TS 12 1,5-2,5	12	Şeffaf / Transparent	1,5 - 2,5	500
8021343039	TS 15 1,5-2,5	15	Şeffaf / Transparent	1,5 - 2,5	500
8021343049	TS 20 1,5-2,5	20	Şeffaf / Transparent	1,5 - 2,5	500
8021343059	TS 30 1,5-2,5	30	Şeffaf / Transparent	1,5 - 2,5	500
8021344019	TS 10 2,5-4,0	10	Şeffaf / Transparent	2,5 - 4	500
8021344029	TS 12 2,5-4,0	12	Şeffaf / Transparent	2,5 - 4	500
8021344039	TS 15 2,5-4,0	15	Şeffaf / Transparent	2,5 - 4	500
8021344049	TS 20 2,5-4,0	20	Şeffaf / Transparent	2,5 - 4	500
8021344059	TS 30 2,5-4,0	30	Şeffaf / Transparent	2,5 - 4	500
8021345019	TS 10 6,0-10	10	Şeffaf / Transparent	6 - 10	500
8021345029	TS 12 6,0-10	12	Şeffaf / Transparent	6 - 10	500
8021345039	TS 15 6,0-10	15	Şeffaf / Transparent	6 - 10	500
8021345049	TS 20 6,0-10	20	Şeffaf / Transparent	6 - 10	500
8021345059	TS 30 6,0-10	30	Şeffaf / Transparent	6 - 10	500
8021346019	TS 10 16-25	10	Şeffaf / Transparent	16 - 25	500
8021346029	TS 12 16-25	12	Şeffaf / Transparent	16 - 25	500
8021346039	TS 15 16-25	15	Şeffaf / Transparent	16 - 25	500
8021346049	TS 20 16-25	20	Şeffaf / Transparent	16 - 25	200
8021346059	TS 30 16-25	30	Şeffaf / Transparent	16 - 25	200

İnce Yapışkanlı Etiketler (Pano Yüzeyi, Kontaktör ve Pano İçi Diğer Cihazlar için)

Slim Adhesive Labels (For Panel Surface, Contactors and Other Devices Inside Panel)

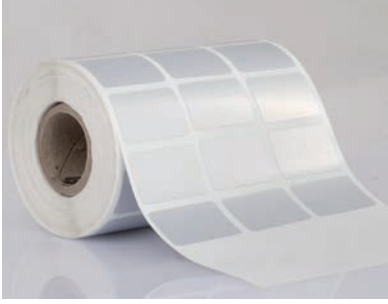

SPEL 27x15



SPEL 35x15



SPEL 15x6

Ürün Kodu Product Code	Ürün Adı Product Name	Yazım Alanı Print Area (mm)	Renk Color	Amb. Mik. Pack. Qty. (Ad./Pcs.)
8022120004	SPEL 12x9	12x9	Sarı / Yellow	2.500
8022120008	SPEL 12x9	12x9	Gümüş / Silver	2.500
8022120009	SPEL 12x9	12x9	Beyaz / White	2.500
8022120014	SPEL 15x6	15x6	Sarı / Yellow	2.500
8022120018	SPEL 15x6	15x6	Gümüş / Silver	2.500
8022120019	SPEL 15x6	15x6	Beyaz / White	2.500
8022120024	SPEL 15x9	15x9	Sarı / Yellow	2.500
8022120028	SPEL 15x9	15x9	Gümüş / Silver	2.500
8022120029	SPEL 15x9	15x9	Beyaz / White	2.500
8022120034	SPEL 17x10	17x10	Sarı / Yellow	2.500
8022120038	SPEL 17x10	17x10	Gümüş / Silver	2.500
8022120039	SPEL 17x10	17x10	Beyaz / White	2.500
8022120044	SPEL 20x8	20x8	Sarı / Yellow	2.500
8022120048	SPEL 20x8	20x8	Gümüş / Silver	2.500
8022120049	SPEL 20x8	20x8	Beyaz / White	2.500
8022120054	SPEL 27x12,5	27x12	Sarı / Yellow	2.500
8022120058	SPEL 27x12,5	27x12	Gümüş / Silver	2.500
8022120059	SPEL 27x12,5	27x12	Beyaz / White	2.500
8022120064	SPEL 27x15	27x15	Sarı / Yellow	2.500
8022120068	SPEL 27x15	27x15	Gümüş / Silver	2.500
8022120069	SPEL 27x15	27x15	Beyaz / White	2.500
8022120074	SPEL 27x18	27x18	Sarı / Yellow	2.500
8022120078	SPEL 27x18	27x18	Gümüş / Silver	2.500
8022120079	SPEL 27x18	27x18	Beyaz / White	2.500
8022120098	SPEL 35x18	35x18	Gümüş / Silver	1.500
8022120108	SPEL 45x15	45x15	Gümüş / Silver	2.000
8022120118	SPEL 70x30	70x30	Gümüş / Silver	250
8022120128	SPEL 90x40	90x40	Gümüş / Silver	250
8022120138	SPEL 100x50	100x50	Gümüş / Silver	250



Kalın Yapışkanlı Etiketler (Pano Yüzeyi için)

Thick Adhesive Labels (For Panel Surface)



TPEL 40x30

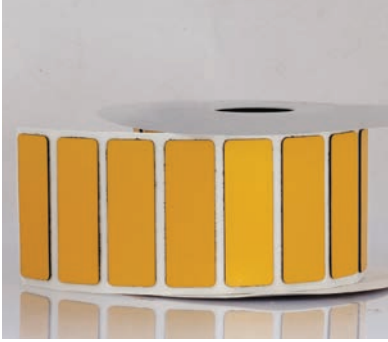

TPEL 60x15



TPEL 45x15

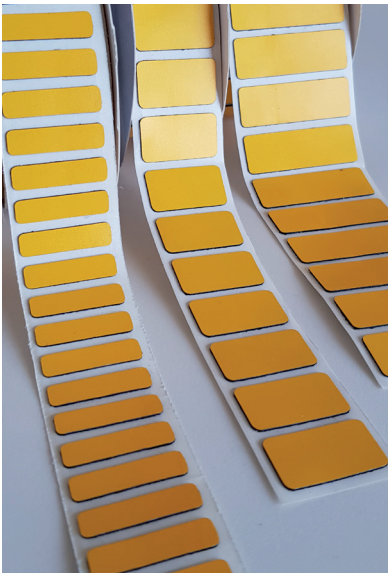

Ürün Kodu Product Code	Ürün Adı Product Name	Yazım Alanı Print Area (mm)	Renk Color	Amb. Mik. Pack. Qty. (Ad./Pcs.)
8022130014	TPEL 22x22	22x22	Sarı / Yellow	150
8022130018	TPEL 22x22	22x22	Gümüş / Silver	150
8022130019	TPEL 22x22	22x22	Beyaz / White	150
8022130004	TPEL 27x12,5	27x12	Sarı / Yellow	150
8022130008	TPEL 27x12,5	27x12	Gümüş / Silver	150
8022130009	TPEL 27x12,5	27x12	Beyaz / White	150
8022130024	TPEL 27x15	27x15	Sarı / Yellow	150
8022130028	TPEL 27x15	27x15	Gümüş / Silver	150
8022130029	TPEL 27x15	27x15	Beyaz / White	150
8022130109	TPEL 27x18	27x18	Sarı / Yellow	150
8022130108	TPEL 27x18	27x18	Gümüş / Silver	150
8022130104	TPEL 27x18	27x18	Beyaz / White	150
8022130034	TPEL 27x27	27x27	Sarı / Yellow	150
8022130038	TPEL 27x27	27x27	Gümüş / Silver	150
8022130039	TPEL 27x27	27x27	Beyaz / White	150
8022130044	TPEL 35x18	35x18	Sarı / Yellow	150
8022130048	TPEL 35x18	35x18	Gümüş / Silver	150
8022130049	TPEL 35x18	35x18	Beyaz / White	150
8022130054	TPEL 40x30	40x30	Sarı / Yellow	125
8022130058	TPEL 40x30	40x30	Gümüş / Silver	125
8022130059	TPEL 40x30	40x30	Beyaz / White	125
8022130064	TPEL 45x15	45x15	Sarı / Yellow	150
8022130068	TPEL 45x15	45x15	Gümüş / Silver	150
8022130069	TPEL 45x15	45x15	Beyaz / White	150
8022130074	TPEL 60x15	60x15	Sarı / Yellow	150
8022130078	TPEL 60x15	60x15	Gümüş / Silver	150
8022130079	TPEL 60x15	60x15	Beyaz / White	150
8022130084	TPEL 60x30	60x30	Sarı / Yellow	125
8022130088	TPEL 60x30	60x30	Gümüş / Silver	125
8022130089	TPEL 60x30	60x30	Beyaz / White	125
8022130094	TPEL 90x45	90x45	Sarı / Yellow	50
8022130098	TPEL 90x45	90x45	Gümüş / Silver	50
8022130099	TPEL 90x45	90x45	Beyaz / White	50



Buton Etiketleri (22 mm Çapa Uygun)

Push Button Labels (Suitable for 22 mm Diameter)



TPBL 30x40



Ürün Kodu Product Code	Ürün Adı Product Name	Yazım Alanı Print Area (mm)	Renk Color	Delik Çapı Hole Dia. (mm)	Amb. Mik. Pack. Qty. (Ad./Pcs.)
8022130114	TPBL 30x40	30 x 13	Sarı / Yellow	23,5	100
8022130118	TPBL 30x40	30 x 13	Gümüş / Silver	23,5	100
8022130119	TPBL 30x40	30 x 13	Beyaz / White	23,5	100



TPBL 30x40

Buton Etiket Tutucular (22 mm Çapa Uygun)

Push Button Labels (Suitable for 22 mm Diameter)



TBET 50X30

TBET 40X30

Ürün Kodu Product Code	Ürün Adı Product Name	Yazım Alanı Print Area (mm)	Renk Color	Amb. Mik. Pack. Qty. (Ad./Pcs.)
8022130330	TBET 40x30	25 x 8	Siyah / Black	60
8022130340	TBET 50x30	25 x 18	Siyah / Black	60

Boş yazım kağıtları paketin içerisinde.
Empty printing papers are inside the package

Yapışkanlı Pano Etiket Tutucular

Self Adhesive Panel Labels Holders



TYPET 17x75



TYPET 17x50



TYPET 17x30

Ürün Kodu Product Code	Ürün Adı Product Name	Yazım Alanı Print Area (mm)	Renk Color	Amb. Mik. Pack. Qty. (Ad./Pcs.)
8022130300	TYPET 17x30	27 x 14	Siyah / Black	100
8022130310	TYPET 17x50	49 x 15	Siyah / Black	50
8022130320	TYPET 17x75	72 x 15	Siyah / Black	25

Boş yazım kağıtları paketin içerisinde.
Empty printing papers are inside the package



Klemens Grup Etiketleri için Etiketler

Labels for Terminal Blocks Group Markers

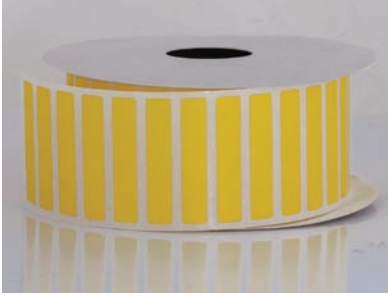

GML 2 36x7

Ürün Kodu Product Code	Ürün Adı Product Name	Yazım Alanı Print Area (mm)	Renk Color	Uyumlu Ürün Explanation	Amb. Mik. Pack. Qty. (Ad./Pcs.)
8022130124	GML 1 36x17	36 x 17	Sarı / Yellow	GM 1	2.000
8022130134	GML 2 36x7	36 x 7	Sarı / Yellow	GM 2	2.000

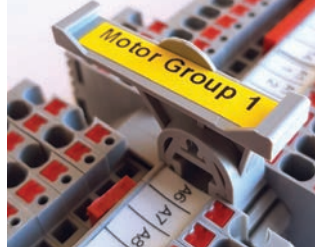

Yapışkanlı Bant Etiketler

Self Adhesive Endless Labels



SALT 5x20

Ürün Kodu Product Code	Ürün Adı Product Name	Ölçüler Dimensions (mmxm)	Renk Color	Amb. Mik. Pack. Qty. (Ad./Pcs.)
8022130144	SALT 5x20	50 x 20	Sarı / Yellow	1
8022130128	SALT 5x20	50 x 20	Gümüş / Silver	1
8022130129	SALT 5x20	50 x 20	Beyaz / White	1

Acil Stop Etiketleri (22mm Çapa Uygun)

Emergency Stop Labels (Suitable for 22mm Diameter)



Ürün Kodu Product Code	Ürün Adı Product Name	Etiket Çapı Label Dia. (mm)	Delik Çapı Hole Dia. (mm)	Renk Color	Amb. Mik. Pack. Qty. (Ad./Pcs.)
8022130350	ASE60	60	23,5	Sarı / Yellow	1

Kablo Bağı ile Bağlanan Etiketler (Doğrudan Kablo Bağına Takılan)

Labels Assembled with Cable Ties (Directly Assembled to Cable Ties)



RCTL 50x15

HCTL 25x10

Ürün Kodu Product Code	Ürün Adı Product Name	Yazım Alanı Print Area (mm)	Renk Color	Açıklama Explanation	Amb. Mik. Pack. Qty. (Ad./Pcs.)
8021341019	HCTL 25x10	25 x 10	Beyaz / White	Altıgen / Hexagonal	250
8021342019	RCTL 25x10	25 x 10	Beyaz / White	Dikdörtgen / Rectangular	250
8021342029	RCTL 50x15	50 x 15	Beyaz / White	Dikdörtgen / Rectangular	250
8021342039	RCTL 60x30	60 x 30	Beyaz / White	Dikdörtgen / Rectangular	250

Kablo Bağı ile Bağlanan Etiketler (Etiket Kılıfıyla Bağlananlar)

Labels Assembled with Cable Ties (Assembled with Label Holder)

Ürün Kodu Product Code	Ürün Adı Product Name	Yazım Alanı Print Area (mm)	Renk Color	Açıklama Explanation	Amb. Mik. Pack. Qty. (Ad./Pcs.)
8021334009	CM 1		Beyaz / White	Etiket Kılıfı 1 / Label Holder 1	100
8021334019	CM 2		Beyaz / White	Etiket Kılıfı 2 / Label Holder 2	100

Boş yazım kağıtları paketin içerisinde.
Empty printing papers are inside the package

Ürün Kodu Product Code	Ürün Adı Product Name	Renk Color	Ölçüler / Dimensions		
			L	W	T
8021334009	CM 1	Beyaz / White	35	10	8
8021334019	CM 2	Beyaz / White	45	20	8

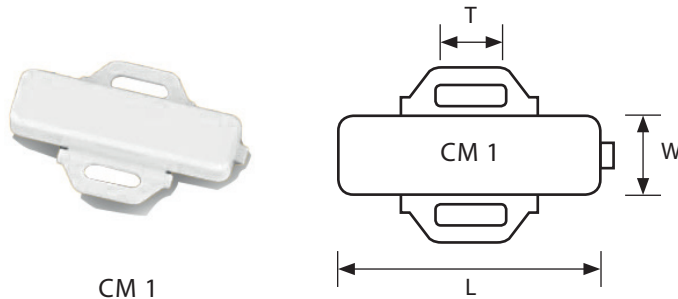

CM 1

Plastik Kablo Bağları

Plastic Cable Ties

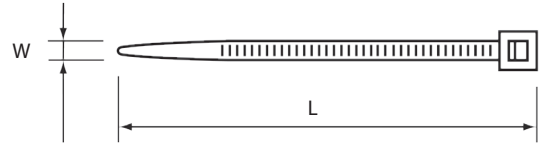
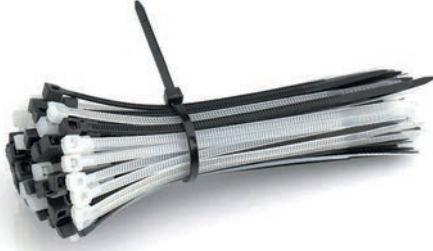

Ürün Kodu Product Code	Ürün Adı Product Name	Ölçüler (BoyxEn) Dimensions (LxW) (mm)	Maks. Sıkma Çapı Max. Bundle Dia. (mm)	Min. Açılma Mukavemeti Min. Loop Tensile Strenght (kg.)	Amb. Mik. Pack. Qty (Adet/Pcs.)	Koli Mik. Carton Qty. (Adet/Pcs.)
8016330109	PCT 100 x 2.5 Beyaz / White	100 x 2.5	22	8	100	26.000
8016330110	PCT 100 x 2.5 Siyah / Black	100 x 2.5	22	8	100	26.000
8016330209	PCT 150 x 2.5 Beyaz / White	150 x 2.5	35	8	100	20.000
8016330210	PCT 150 x 2.5 Siyah / Black	150 x 2.5	35	8	100	20.000
8016330309	PCT 200 x 2.5 Beyaz / White	200 x 2.5	55	8	100	18.000
8016330310	PCT 200 x 2.5 Siyah / Black	200 x 2.5	55	8	100	18.000
8016330409	PCT 140 x 3.6 Beyaz / White	140 x 3.6	36	18	100	12.000
8016330410	PCT 140 x 3.6 Siyah / Black	140 x 3.6	36	18	100	12.000
8016330509	PCT 200 x 3.6 Beyaz / White	200 x 3.6	52	18	100	10.000
8016330510	PCT 200 x 3.6 Siyah / Black	200 x 3.6	52	18	100	10.000
8016330609	PCT 250 x 3.6 Beyaz / White	250 x 3.6	68	18	100	8.000
8016330610	PCT 250 x 3.6 Siyah / Black	250 x 3.6	68	18	100	8.000
8016330709	PCT 280 x 3.6 Beyaz / White	280 x 3.6	82	18	100	8.000
8016330710	PCT 280 x 3.6 Siyah / Black	280 x 3.6	82	18	100	8.000
8016330809	PCT 370 x 3.6 Beyaz / White	370 x 3.6	105	18	100	6.000
8016330810	PCT 370 x 3.6 Siyah / Black	370 x 3.6	105	18	100	6.000
8016331009	PCT 200 x 4.8 Beyaz / White	200 x 4.8	49	22	100	7.000
8016331010	PCT 200 x 4.8 Siyah / Black	200 x 4.8	49	22	100	7.000
8016331209	PCT 250 x 4.8 Beyaz / White	250 x 4.8	68	22	100	6.000
8016331210	PCT 250 x 4.8 Siyah / Black	250 x 4.8	68	22	100	6.000
8016331309	PCT 300 x 4.8 Beyaz / White	300 x 4.8	83	22	100	5.000
8016331310	PCT 300 x 4.8 Siyah / Black	300 x 4.8	83	22	100	5.000
8016331509	PCT 370 x 4.8 Beyaz / White	370 x 4.8	105	22	100	4.000
8016331510	PCT 370 x 4.8 Siyah / Black	370 x 4.8	105	22	100	4.000
8016331709	PCT 430 x 4.8 Beyaz / White	430 x 4.8	125	22	100	3.000
8016331710	PCT 430 x 4.8 Siyah / Black	430 x 4.8	125	22	100	3.000
8016332009	PCT 300 x 7.6 Beyaz / White	300 x 7.6	80	55	100	3.000
8016332010	PCT 300 x 7.6 Siyah / Black	300 x 7.6	80	55	100	3.000
8016332209	PCT 370 x 7.6 Beyaz / White	370 x 7.6	101	55	100	2.500
8016332210	PCT 370 x 7.6 Siyah / Black	370 x 7.6	101	55	100	2.500
8016332309	PCT 450 x 7.6 Beyaz / White	450 x 7.6	128	55	100	2.500
8016332310	PCT 450 x 7.6 Siyah / Black	450 x 7.6	128	55	100	2.500
8016332329	PCT 550 x 7.6 Beyaz / White	550 x 7.6	155	55	100	1.500
8016332320	PCT 550 x 7.6 Siyah / Black	550 x 7.6	155	55	100	1.500
8016332339	PCT 750 x 7.6 Beyaz / White	750 x 7.6	220	55	100	1.200
8016332330	PCT 750 x 7.6 Siyah / Black	750 x 7.6	220	55	100	1.200
8016332409	PCT 600 x 9.0 Beyaz / White	600 x 9.0	160	80	100	1.200
8016332410	PCT 600 x 9.0 Siyah / Black	600 x 9.0	160	80	100	1.200
8016332609	PCT 760 x 9.0 Beyaz / White	760 x 9.0	227	80	100	1.200
8016332610	PCT 760 x 9.0 Siyah / Black	760 x 9.0	227	80	100	1.200
8016332709	PCT 900 x 9.0 Beyaz / White	900 x 9.0	275	80	100	1.200
8016332710	PCT 900 x 9.0 Siyah / Black	900 x 9.0	275	80	100	1.200

• Siyah renkli kablo bağları UV (Ultraviyole) ışınlarına karşı dayanıklıdır.

• Black colored cable ties are UV (Ultraviolet) resistant.

Yapışkan Kroşeler

Self Adhesive Tie Mounts

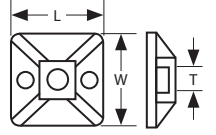

Ürün Kodu Product Code	Ürün Adı Product Name	Ölçüler Dimensions (mm)			Amb. Mik. Pack. Qty (Adet/Pcs.)
		L	W	T	
8016333009	ATM 19 x 19 Beyaz / White	19	19	3,6	100
8016333010	ATM 19 x 19 Siyah / Black	19	19	3,6	100
8016333109	ATM 28 x 28 Beyaz / White	28	28	4,8	100
8016333110	ATM 28 x 28 Siyah / Black	28	28	4,8	100

Vidalı Kroşeler

Screw Type Tie Mounts

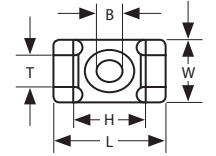

Ürün Kodu Product Code	Ürün Adı Product Name	Ölçüler Dimensions					Amb. Mik. Pack. Qty (Adet/Pcs.)
		L	W	H	T	B	
8016334009	STM 1 Beyaz / White	17,8	12,7	8,15	4,8	M3	100
8016334019	STM 2 Beyaz / White	25,4	16	10,8	9	M5	100
8016334010	STM 1 Siyah / Black	17,8	12,7	8,15	4,8	M3	100
8016334020	STM 2 Siyah / Black	25,4	16	10,8	9	M5	100

Kablo Bağı Sıkma ve Kesme Aleti

Cable Tie Tightening and Cutting Tool



Ürün Kodu Product Code	Ürün Adı Product Name	Özellik Function	Maks. Kablo Bağı Eni Max. Cable Tie Width (mm)	Amb. Mik. Pack. Qty (Adet/Pcs.)
8016334200	CTT1	Sıkma + Kesme Tightening + Cutting	4,8	1

Sıkmalı Kablo Pabuçları - Standart Seri

Standart Range Compression Cable Lugs - Standard Line

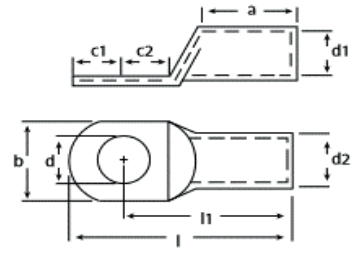

Ürün Kodu Product Code	Ürün Adı Product Name	Kesit Cross Sec. (mm ²)	Ölçüler / Dimensions (mm)									Delik Çapı Hole Dia.	Amb. Mik. Pack. Qty. (Adet/Pcs.)
			d	d1	d2	l	l1	a	b	c1	c2		
8029320610	CCL 10mm² M6	10	6,5	4,4	6	27,5	21,7	10	10,4	6	6	M6	500
8029320620	CCL 10mm² M8	10	8,5	4,4	6	27,5	21,7	10	13,7	6	6	M8	500
8029320630	CCL 16mm² M6	16	6,5	5,5	8	32,6	24,9	12	11,4	7	8	M6	300
8029320640	CCL 16mm² M8	16	8,5	5,5	8	32,6	24,9	12	13,9	7	8	M8	300
8029320641	CCL 16mm ² M10	16	10,5	5,5	8	32,6	24,9	12	16,1	7	8	M10	300
8029320649	CCL 25mm ² M6	25	6,5	6,8	9	39	32,3	16	13,6	6,8	9,2	M6	200
8029320650	CCL 25mm² M8	25	8,5	6,8	9	39	32,3	16	13,7	6,8	9,2	M8	200
8029320651	CCL 25mm ² M10	25	10,5	7	9,5	42	34,1	16	16,1	6,8	11	M10	200
8029320659	CCL 35mm ² M6	35	6,5	8,2	11	44	35,6	19	15,9	8,3	9,7	M6	150
8029320660	CCL 35mm² M8	35	8,5	8,2	11	44	35,6	19	15,9	8,3	9,7	M8	150
8029320661	CCL 35mm ² M10	35	10,5	8,2	11	48	37,9	19	15,8	10	12	M10	150
8029320669	CCL 50mm ² M8	50	8,5	9,5	12	47,5	39,3	21	17,8	8,3	9,7	M8	100
8029320670	CCL 50mm² M10	50	10,5	9,5	12	51,5	41,6	21	17,9	10	12	M10	100
8029320671	CCL 50mm ² M12	50	13	10,1	13	51,5	41,6	21	19,2	10	12	M12	100
8029320672	CCL 50mm ² M14	50	15	10,1	13	56,5	44,6	21	20,7	12	15	M14	100
8029320679	CCL 70mm ² M8	70	8,5	11,2	14,5	54,6	44,5	23	21,2	10	12	M8	75
8029320680	CCL 70mm² M10	70	10,5	11,2	14,5	54,6	44,5	23	21,2	10	12	M10	75
8029320681	CCL 70mm ² M12	70	13	11,2	14,5	54,6	44,5	23	21,3	10	12	M12	75
8029320682	CCL 70mm ² M14	70	15	11,2	14,5	62,6	47,5	23	21,5	15	15	M14	75
8029320689	CCL 95mm ² M8	95	8,5	13,4	17	58,8	48,9	26	24,7	10	12	M8	50
8029320690	CCL 95mm² M10	95	10,5	13,4	17	58,8	48,9	26	24,7	10	12	M10	50
8029320700	CCL 95mm² M12	95	13	13,4	17	58,8	48,9	26	24,6	10	12	M12	50
8029320709	CCL 120mm ² M10	120	10,5	15,5	19	69	55,9	29	28,1	13	14,5	M10	40
8029320710	CCL 120mm² M12	120	13	15,5	19	69	55,9	29	28,2	13	14,5	M12	40
8029320711	CCL 120mm ² M16	120	17	15,5	19	69	55,9	29	28,2	13	14,5	M16	40
8029320719	CCL 150mm ² M10	150	10,5	16,5	16,5	76,5	59,9	30	30,2	16,5	16,5	M10	30
8029320720	CCL 150mm² M12	150	13	16,5	21	76,5	59,9	30	30,1	16,5	16,5	M12	30
8029320721	CCL 150mm ² M16	150	17	16,5	21	76,5	59,9	30	30,1	16,5	16,5	M16	30
8029320729	CCL 185mm ² M12	185	13	18,5	23	82,5	65,6	33	34,2	17	18	M12	25
8029320730	CCL 185mm² M16	185	17	18,5	23	82,5	65,6	33	34,1	17	18	M16	25
8029320739	CCL 240mm ² M12	240	13	21	26	89	72,1	38	38,2	17	18	M12	20
8029320740	CCL 240mm² M16	240	17	21	26	89	72,1	38	38,2	17	18	M16	20



Malzeme : EN 13600 Standardında elektrolitik bakır
Kaplama : Minimum 3 mikron (µm) Kalay Kaplama

Material : EN 13600 Standarts Electrolytically Tin (E-Cu) Plated Copper
 Plating : Minimum 3 microns (µm) Tin Plated

**** Koyu renk ile işaretlenmiş kablo pabuçları standart ürünlerimiz olup, diğer kalemler için lütfen stok durumunu sorunuz.**

**** Bold fonted items are our standart sizes, pls ask stock availability for other items.**

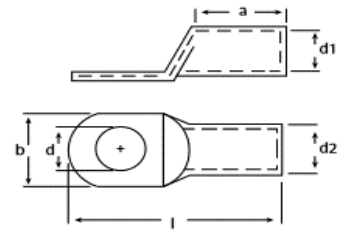

Standart Kablo Pabuçları - Eko Seri

Compression Cable Lugs - Eco Line

Ürün Kodu Product Code	Ürün Adı Product Name	Kesit Cross Sec. (mm ²)	Ölçüler / Dimensions (mm)						Delik Çapı Hole Dia.	Amb. Mik. Pack. Qty. (Adet/Pcs.)
			d	d1	d2	l	a	b		
8029320500	CCL-E 16 M6	16	6,5	5,5	7	32,5	11	10,5	M6	500
8029320510	CCL-E 16 M8	16	8,5	5,5	7	32,5	11	13	M8	500
8029320520	CCL-E 25 M8	25	8,5	7	9	38,5	16	13	M8	300
8029320530	CCL-E 35 M8	35	8,5	8,5	10,5	43,5	19	15,5	M8	200
8029320540	CCL-E 50 M10	50	10,5	10	12	51,5	21	17,6	M10	125
8029320550	CCL-E 70 M10	70	10,5	11,5	14	55,5	23	20,7	M10	100
8029320560	CCL-E 95 M12	95	13	13,5	16	58,5	26	23,5	M12	75
8029320570	CCL-E 120 M12	120	13	15,5	18	71	29	26,7	M12	50
8029320580	CCL-E 150 M12	150	13	16,5	20	76	30	29,2	M12	30
8029320590	CCL-E 185 M16	185	17	18,5	22	82	33	32,3	M16	25
8029320600	CCL-E 240 M16	240	17	21,5	25,5	91	38	37,6	M16	20

Malzeme : EN 13600 Standardında elektrolitik bakır
Kaplama : Minimum 3 mikron (µm) Kalay Kaplama

Material : EN 13600 Standarts Electrolytically Tin (E-Cu) Plated Copper
Plating : Minimum 3 microns (µm) Tin Plated



Standart Seri Ek Muflar

Standard Range Compression Butt Terminals

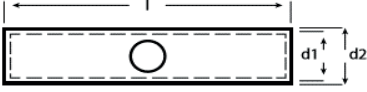

Ürün Kodu Product Code	Ürün Adı Product Name	Kesit Cross Sec. (mm ²)	Ölçüler / Dimensions (mm)			Amb. Mik. Pack. Qty. (Adet/Pcs.)
			d1	d2	l	
8029320845	CBT 10	10	4,4	6	27	400
8029320850	CBT 16	16	5,5	8	32	250
8029320860	CBT 25	25	7	9	40,5	200
8029320870	CBT 35	35	8,2	11	45,5	150
8029320880	CBT 50	50	9,5	13	53,5	80
8029320890	CBT 70	70	11,2	14,5	57,5	60
8029320900	CBT 95	95	13,4	17	61,5	40
8029320910	CBT 120	120	15	19,5	74	30
8029320920	CBT 150	150	16,5	21	79	25
8029320930	CBT 185	185	19	24	85	18
8029320940	CBT 240	240	21	26	95	13

Malzeme : EN 13600 Standardında elektrolitik bakır

Kaplama : Minimum 3 mikron (µm) Kalay Kaplama

Material : EN 13600 Standarts Electrolytically Tin (E-Cu) Plated Copper

Plating : Minimum 3 microns (µm) Tin Plated

Eko Seri Ek Muflar

Economical Range Compression Butt Terminals

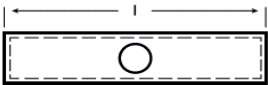

Ürün Kodu Product Code	Ürün Adı Product Name	Kesit Cross Sec. (mm ²)	Uzunluk Lenght (l) mm	Amb. Mik. Pack. Qty. (Adet/Pcs.)
8029320750	CBT-E 16	16	32	300
8029320760	CBT-E 25	25	41	200
8029320770	CBT-E 35	35	46	150
8029320780	CBT-E 50	50	54	125
8029320790	CBT-E 70	70	58	100
8029320800	CBT-E 95	95	62	60
8029320810	CBT-E 120	120	74	40
8029320820	CBT-E 150	150	80	30
8029320830	CBT-E 185	185	86	22
8029320840	CBT-E 240	240	95	15

Malzeme : EN 13600 Standardında elektrolitik bakır

Kaplama : Minimum 3 mikron (µm) Kalay Kaplama

Material : EN 13600 Standarts Electrolytically Tin (E-Cu) Plated Copper

Plating : Minimum 3 microns (µm) Tin Plated

Yuvarlak Pabuçlar

Insulated Ring Terminals

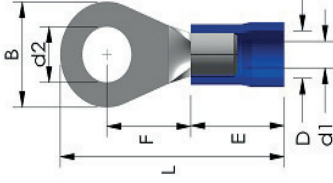

Malzeme: Bakır, Kalay Kaplı
Material: Copper, Tin Plated
İzolasyon / Isolation PVC

Ürün Kodu Product Code	Ürün Adı Product Name	Kesit Cross Sect. (mm ²)	Ölçüler Dimensions (mm)							Renk Color	Amb. Mik. Pack. Qty (Adet/Pcs.)
			d2	B	F	L	E	D	d1		
8018335500	IRT 301	0,5 - 1,5	3,2	5,5	4	16,7	10	4,1	1,7	Kırmızı / Red	200
8018335510	IRT 351	0,5 - 1,5	3,7	5,5	4	16,7	10	4,1	1,7	Kırmızı / Red	200
8018335520	IRT 401	0,5 - 1,5	4,3	6,6	6,3	19,6	10	4,1	1,7	Kırmızı / Red	200
8018335530	IRT 501	0,5 - 1,5	5,3	8	7	21	10	4,1	1,7	Kırmızı / Red	200
8018335540	IRT 601	0,5 - 1,5	6,5	11,6	11,1	26,8	10	4,1	1,7	Kırmızı / Red	200
8018335550	IRT 801	0,5 - 1,5	8,4	11,6	11,1	26,8	10	4,1	1,7	Kırmızı / Red	200
8018335560	IRT 302	1,5 - 2,5	3,2	6,4	4,3	17,5	10	4,5	2,3	Mavi / Blue	200
8018335570	IRT 402	1,5 - 2,5	4,3	6,6	6,3	19,5	10	4,5	2,3	Mavi / Blue	200
8018335580	IRT 502	1,5 - 2,5	5,3	8,5	7,8	22	10	4,5	2,3	Mavi / Blue	200
8018335590	IRT 602	1,5 - 2,5	6,5	12	11	27	10	4,5	2,3	Mavi / Blue	200
8018335600	IRT 802	1,5 - 2,5	8,4	12	11	27	10	4,5	2,3	Mavi / Blue	200
8018335610	IRT 1002	1,5 - 2,5	10,5	13,6	13,9	30,7	10	4,5	2,3	Mavi / Blue	100
8018335620	IRT 406	4,0 - 6,0	4,3	7,2	5,9	22	12,5	6,5	3,4	Sarı / Yellow	75
8018335630	IRT 506	4,0 - 6,0	5,3	9,5	8,3	25,5	12,5	6,5	3,4	Sarı / Yellow	75
8018335640	IRT 606	4,0 - 6,0	6,5	12	10,5	29	12,5	6,5	3,4	Sarı / Yellow	75
8018335650	IRT 806	4,0 - 6,0	8,4	15	13,7	33,7	12,5	6,5	3,4	Sarı / Yellow	75
8018335660	IRT 1006	4,0 - 6,0	10,5	15	13,7	33,7	12,5	6,5	3,4	Sarı / Yellow	75
8018335670	IRT 1206	4,0 - 6,0	13	19,2	16	38,1	12,5	6,5	3,4	Sarı / Yellow	75
8018335680	IRT 510	8,0 - 10,0	5,3	12	9,7	32,5	17	8	4,5	Kırmızı / Red	50
8018335690	IRT 610	8,0 - 10,0	6,7	12	9,7	32,5	17	8	4,5	Kırmızı / Red	50

Çatal Pabuçlar

Insulated Fork Terminals

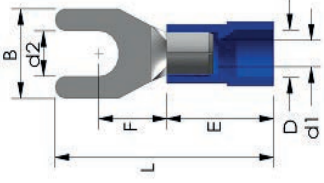

Malzeme: Bakır, Kalay Kaplı
Material: Copper, Tin Plated
İzolasyon / Isolation PVC



Ürün Kodu Product Code	Ürün Adı Product Name	Kesit Cross Sect. (mm ²)	Ölçüler Dimensions (mm)							Renk Color	Amb. Mik. Pack. Qty (Adet/Pcs.)
			d2	B	F	L	E	D	d1		
8018335700	IFT 301	0,5 - 1,5	3,2	5,8	6,3	21	10	4,1	1,7	Kırmızı / Red	200
8018335720	IFT 401	0,5 - 1,5	4,3	6,4	6,3	20,6	10	4,1	1,7	Kırmızı / Red	200
8018335730	IFT 501	0,5 - 1,5	5,3	8	7	21	10	4,1	1,7	Kırmızı / Red	200
8018335740	IFT 601	0,5 - 1,5	6,5	12	11	27,2	10	4,1	1,7	Kırmızı / Red	200
8018335750	IFT 302	1,5 - 2,5	3,2	5,8	6,3	21	10	4,2	2,3	Mavi / Blue	200
8018335760	IFT 402	1,5 - 2,5	4,3	6,4	6,3	21	10	4,2	2,3	Mavi / Blue	200
8018335770	IFT 502	1,5 - 2,5	5,3	9,5	7,2	22	10	4,2	2,3	Mavi / Blue	200
8018335780	IFT 602	1,5 - 2,5	6,5	12	11	27,2	10	4,2	2,3	Mavi / Blue	200
8018335790	IFT 406	4,0 - 6,0	4,3	8,5	7,5	25,2	12,5	6,5	3,4	Sarı / Yellow	75
8018335800	IFT 506	4,0 - 6,0	5,3	9,5	7,5	25,2	12,5	6,5	3,4	Sarı / Yellow	75
8018335810	IFT 606	4,0 - 6,0	6,5	9,5	7,5	25,2	12,5	6,5	3,4	Sarı / Yellow	75
8018335820	IFT 806	4,0 - 6,0	8,4	13,5	10,5	30	12,5	6,5	3,4	Sarı / Yellow	75

Faston Dişi Pabuçlar

Fast-on Female Terminals

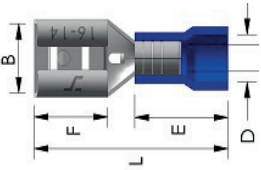

Malzeme: Bakır, Kalay Kaplı
Material: Copper, Tin Plated
İzolasyon / Isolation PVC



Ürün Kodu Product Code	Ürün Adı Product Name	Kesit Cross Sect. (mm ²)	Ölçüler Dimensions (mm)					Renk Color	Amb. Mik. Pack. Qty (Adet/Pcs.)
			B	F	L	E	D		
8018336030	FFT 1288	0,5 - 1,5	3,20	6,5	19,0	10,5	3,8	Kırmızı / Red	200
8018336100	FFT 1488	0,5 - 1,5	5,00	6,4	19,4	10,5	3,8	Kırmızı / Red	200
8018336110	FFT 1638	0,5 - 1,5	6,60	7,5	20,8	10,5	3,8	Kırmızı / Red	200
8018336115	FFT 2288	1,5 - 2,5	5,00	6,4	19,4	10,5	4,7	Mavi / Blue	150
8018336120	FFT 2488	1,5 - 2,5	6,60	7,5	20,8	10,5	4,7	Mavi / Blue	150
8018336130	FFT 2638	1,5 - 2,5	6,60	7,5	23,3	13,0	6,2	Mavi / Blue	150
8018336140	FFT 5638	4,0 - 6,0	6,6	7,2	23,3	13	5,6	Sarı / Yellow	100

İzoleli Faston Dişi Pabuçlar

Insulated Fast-on Female Terminals

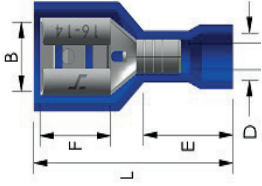

Malzeme: Bakır, Kalay Kaplı
Material: Copper, Tin Plated
İzolasyon / Isolation PVC

Ürün Kodu Product Code	Ürün Adı Product Name	Kesit Cross Sect. (mm ²)	Ölçüler Dimensions (mm)					Renk Color	Amb. Mik. Pack. Qty (Adet/Pcs.)
			B	F	L	E	D		
8018336300	IFFT 1288	0,5 - 1,5	3,2	6,5	19,00	10,50	3,8	Kırmızı / Red	100
8018336310	IFFT 1488	0,5 - 1,5	5	6,4	20,50	10,50	3,8	Kırmızı / Red	100
8018336320	IFFT 1638	0,5 - 1,5	6,6	7,5	21,80	10,50	3,8	Kırmızı / Red	100
8018336325	IFFT 2288	1,5 - 2,5	5	6,4	20,20	10,50	4,7	Mavi / Blue	100
8018336330	IFFT 2488	1,5 - 2,5	6,6	7,5	22,20	10,50	4,7	Mavi / Blue	100
8018336340	IFFT 2638	1,5 - 2,5	6,6	7,5	24,20	12,50	6,2	Mavi / Blue	100
8018336350	IFFT 5638	4,0 - 6,0	6,6	7,2	23,8	13	5,6	Sarı / Yellow	75

Faston Erkek Pabuçlar

Fast-on Male Terminals

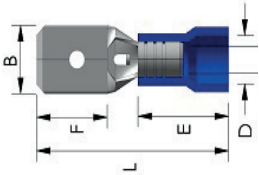

Malzeme: Bakır, Kalay Kaplı
Material: Copper, Tin Plated
İzolasyon / Isolation PVC

Ürün Kodu Product Code	Ürün Adı Product Name	Kesit Cross Sect. (mm ²)	Ölçüler Dimensions (mm)					Renk Color	Amb. Mik. Pack. Qty (Adet/Pcs.)
			B	F	L	E	D		
8018336150	FMT 1288	0,5 - 1,5	2,80	6,5	19,2	10,5	3,8	Kırmızı / Red	200
8018336160	FMT 1488	0,5 - 1,5	4,80	6,7	19,8	10,5	3,8	Kırmızı / Red	200
8018336170	FMT 1638	0,5 - 1,5	6,35	7,7	21,8	10,5	3,8	Kırmızı / Red	200
8018336175	FMT 2288	1,5 - 2,5	4,80	6,7	19,8	10,5	4,7	Mavi / Blue	200
8018336180	FMT 2488	1,5 - 2,5	6,35	7,7	21,8	10,5	4,7	Mavi / Blue	200
8018336190	FMT 2638	1,5 - 2,5	6,35	7,7	24,8	13,0	6,2	Mavi / Blue	200
8018336200	FMT 5638	4,0 - 6,0	6,3	7,7	24	13	5,6	Sarı / Yellow	100

Ger i Dönüřlü Pabuçlar

Piggy Back Terminals

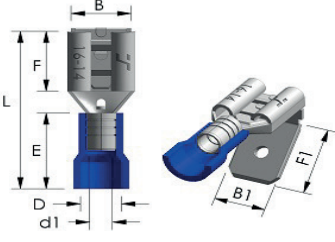

Malzeme: Bakır, Kalay Kaplı
Material: Copper, Tin Plated
İzolasyon / Isolation PVC



Ürün Kodu Product Code	Ürün Adı Product Name	Kesit Cross Sect. (mm ²)	Ölçüler Dimensions (mm)								Renk Color	Amb. Mik. Pack. Qty (Adet/Pcs.)
			B	B1	F	F1	L	E	D	d1		
8018336460	PBT 1638	0,5 - 1,5	6,6	6,3	8	8,2	22	10	3,5	1,7	Kırmızı / Red	100
8018336470	PBT 2638	1,5 - 2,5	6,6	6,3	8	8,2	22	10	4,2	2,3	Mavi / Blue	100
8018336480	PBT 5638	4,0 - 6,0	6,6	6,3	8	8,2	25	13	5,6	3,4	Sarı / Yellow	75

İğne Tip Pabuçlar

Insulated Pin Terminals

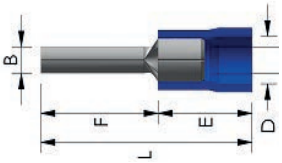

Malzeme: Bakır, Kalay Kaplı
Material: Copper, Tin Plated
İzolasyon / Isolation PVC



Ürün Kodu Product Code	Ürün Adı Product Name	Kesit Cross Sect. (mm ²)	Ölçüler Dimensions (mm)					Renk Color	Amb. Mik. Pack. Qty (Adet/Pcs.)
			B	F	L	E	D		
8018335900	IPT 1/1,5	0,5 - 1,5	1,9	10	20	10	4,0	Kırmızı / Red	200
8018335910	IPT 1/2,5	1,5 - 2,5	1,9	12	22	10	4,5	Mavi / Blue	200
8018335920	IPT 1/6	4,0 - 6,0	2,8	14	27	13	6,4	Sarı / Yellow	100

Diři Pabuçlar

Bullet Female Terminals

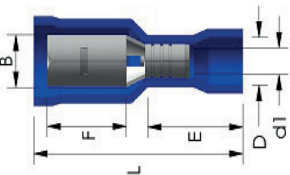

Malzeme: Bakır, Kalay Kaplı
Material: Copper, Tin Plated
İzolasyon / Isolation PVC



Ürün Kodu Product Code	Ürün Adı Product Name	Kesit Cross Sect. (mm ²)	Ölçüler Dimensions (mm)						Renk Color	Amb. Mik. Pack. Qty (Adet/Pcs.)
			B	F	L	E	D	d1		
8018336600	BFT 1040	0,5 - 1,5	3,9	7,3	23,5	10	3,5	1,7	Kırmızı / Red	100
8018336610	BFT 2050	1,5 - 2,5	4,9	8,5	25	10	4,2	2,3	Mavi / Blue	100
8018336620	BFT 5050	4,0 - 6,0	4,9	8,5	28	13	5,6	3,4	Sarı / Yellow	50

Erkek Pabuçlar

Bullet Male Terminals

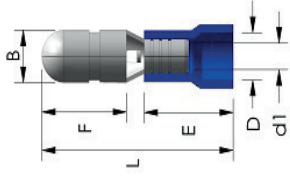

Malzeme: Bakır, Kalay Kaplı
Material: Copper, Tin Plated
İzolasyon / Isolation PVC



Ürün Kodu Product Code	Ürün Adı Product Name	Kesit Cross Sect. (mm ²)	Ölçüler Dimensions (mm)						Renk Color	Amb. Mik. Pack. Qty (Adet/Pcs.)
			B	F	L	E	D	d1		
8018336700	BMT 1040	0,5 - 1,5	4	8,5	21	10	3,5	1,7	Kırmızı / Red	100
8018336710	BMT 2050	1,5 - 2,5	5	9	21,5	10	4,2	2,3	Mavi / Blue	100
8018336720	BMT 5050	4,0 - 6,0	5	9	24,5	13	5,6	3,4	Sarı / Yellow	100

Ek Muflar

Insulated Butt Terminals

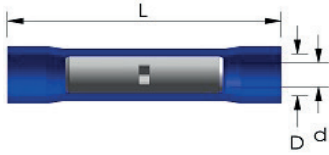

Malzeme: Bakır, Kalay Kaplı
Material: Copper, Tin Plated
İzolasyon / Isolation PVC



Ürün Kodu Product Code	Ürün Adı Product Name	Kesit Cross Sect. (mm ²)	Ölçüler Dimensions (mm)			Renk Color	Amb. Mik. Pack. Qty (Adet/Pcs.)
			L	D	d		
8018336500	IBT 251	0,5 - 1,5	24,5	4,3	1,7	Kırmızı / Red	100
8018336510	IBT 252	1,5 - 2,5	24,5	4,8	2,3	Mavi / Blue	100
8018336520	IBT 256	4,0 - 6,0	27	6,2	3,4	Sarı / Yellow	75

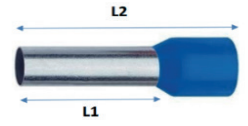

İzoleli Kablo Yüksükleri

Insulated End Sleeves

Malzeme: Bakır, Kalay Kaplı
Material: Copper, Tin Plated
İzolasyon / Isolation PA66



Ürün Kodu Product Code	Ürün Adı Product Name	Ölçüler Dimensions (mm)		Kesit Cross Sect. (mm ²)	AWG	Norm	Amb. Mik. Pack. Qty (Adet/Pcs.)
		L1	L2				
8017335000	IES 0,50/8 Turuncu / Orange	8	12	0,5	20	Alman / German	1.000
8017335010	IES 0,75/8 Beyaz / White	8	14	0,75	18	Alman / German	1.000
8017335020	IES 1,0/8 Sarı / Yellow	8	14	1	17	Alman / German	1.000
8017335030	IES 1,5/8 Kırmızı / Red	8	14	1,5	16	Alman / German	1.000
8017335040	IES 2,5/8 Mavi / Blue	8	14	2,5	14	Alman / German	500
8017335050	IES 4,0/10 Gri / Gray	10	17	4	12	Alman / German	500
8017335060	IES 6,0/12 Siyah / Black	12	20	6	10	Alman / German	250
8017335070	IES 10,0/12 Fildişi / Ivory	12	22	10	8	Alman / German	100
8017335080	IES 16,0/12 Yeşil / Green	12	24	16	6	Alman / German	100
8017335090	IES 25,0/16 Kahve / Brown	16	28	25	4	Alman / German	50
8017335100	IES 35,0/16 Bej / Beige	16	30	35	2	Alman / German	50
8017335110	IES 50,0/20 Zeytin Yeşili / Olive Green	20	36	50	1	Alman / German	25

Ürün Kodu Product Code	Ürün Adı Product Name	Ölçüler Dimensions (mm)		Kesit Cross Sect. (mm ²)	AWG	Norm	Amb. Mik. Pack. Qty (Adet/Pcs.)
		L1	L2				
8017335005	IES 0,50/8 Beyaz / White	8	12	0,5	20	Fransız / French	1.000
8017335015	IES 0,75/8 Mavi / Blue	8	14	0,75	18	Fransız / French	1.000
8017335025	IES 1,0/8 Kırmızı / Red	8	14	1	17	Fransız / French	1.000
8017335035	IES 1,5/8 Siyah / Black	8	14	1,5	16	Fransız / French	1.000
8017335045	IES 2,5/8 Gri / Gray	8	14	2,5	14	Fransız / French	500
8017335055	IES 4,0/10 Turuncu / Orange	10	17	4	12	Fransız / French	500
8017335065	IES 6,0/12 Yeşil / Green	12	20	6	10	Fransız / French	250
8017335075	IES 10,0/12 Kahve / Brown	12	22	10	8	Fransız / French	100
8017335085	IES 16,0/12 Bej / Beige	12	24	16	6	Fransız / French	100
8017335095	IES 25,0/16 Siyah / Black	16	28	25	4	Fransız / French	50
8017335105	IES 35,0/16 Kırmızı / Red	16	30	35	2	Fransız / French	50
8017335115	IES 50,0/20 Mavi / Blue	20	36	50	1	Fransız / French	25



Çift Girişli Kablo Yüksükleri

Twin Cord End Sleeves

Malzeme: Bakır, Kalay Kaplı
Material: Copper, Tin Plated
İzolasyon / Isolation PA66

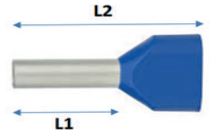

Ürün Kodu Product Code	Ürün Adı Product Name	Ölçüler Dimensions (mm)		Kesit Cross Sect. (mm ²)	Norm	Amb. Mik. Pack. Qty (Adet/Pcs.)
		L1	L2			
8017335400	IES 2x0,50/8 Turuncu / Orange	8	14	2 x 0,5	Alman / German	1.000
8017335410	IES 2x0,75/8 Beyaz / White	8	14	2 x 0,75	Alman / German	500
8017335420	IES 2x1,0/8 Sarı / Yellow	8	14	2 x 1,0	Alman / German	500
8017335430	IES 2x1,5/8 Kırmızı / Red	8	14	2 x 1,5	Alman / German	500
8017335440	IES 2x2,5/10 Mavi / Blue	10	14	2 x 2,5	Alman / German	250
8017335450	IES 2x4,0/12 Gri / Gray	12	17	2 x 4,0	Alman / German	200
8017335460	IES 2x6,0/14 Siyah / Black	14	20	2 x 6,0	Alman / German	100
8017335470	IES 2x10,0/14 Fildişi / Ivory	14	27	2 x 10	Alman / German	50
8017335480	IES 2x16,0/14 Yeşil / Green	14	31	2 x 16	Alman / German	50

Ürün Kodu Product Code	Ürün Adı Product Name	Ölçüler Dimensions (mm)		Kesit Cross Sect. (mm ²)	Norm	Amb. Mik. Pack. Qty (Adet/Pcs.)
		L1	L2			
8017335405	IES 2x0,50/8 Beyaz / White	8	14	2 x 0,5	Fransız / French	1.000
8017335415	IES 2x0,75/8 Mavi / Blue	8	14	2 x 0,75	Fransız / French	500
8017335425	IES 2x1,0/8 Kırmızı / Red	8	14	2 x 1,0	Fransız / French	500
8017335435	IES 2x1,5/8 Siyah / Black	8	14	2 x 1,5	Fransız / French	500
8017335445	IES 2x2,5/10 Gri / Gray	10	14	2 x 2,5	Fransız / French	250
8017335455	IES 2x4,0/12 Turuncu / Orange	12	17	2 x 4,0	Fransız / French	200
8017335465	IES 2x6,0/14 Yeşil / Green	14	20	2 x 6,0	Fransız / French	100
8017335475	IES 2x10,0/14 Kahve / Brown	14	27	2 x 10	Fransız / French	50
8017335485	IES 2x16,0/14 Bej / Beige	14	31	2 x 16	Fransız / French	50



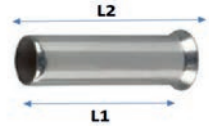

İzolesiz Kablo Yüksükleri

Non-insulated End Sleeves

Malzeme: Bakır, Kalay Kaplı
Material: Copper, Tin Plated



Ürün Kodu Product Code	Ürün Adı Product Name	Ölçüler Dimensions (mm)		Kesit Cross Sect. (mm ²)	AWG	Amb. Mik. Pack. Qty (Adet/Pcs.)
		L1	L2			
8017335220	ES 0,50/10	8	10	0,50	20	2.000
8017335230	ES 0,75/10	8	10	0,75	18	2.000
8017335240	ES 1,0/10	8	10	1,00	17	2.000
8017335250	ES 1,5/10	8	10	1,50	15	2.000
8017335260	ES 2,5/12	8	12	2,50	13	2.000
8017335270	ES 4,0/12	10	12	4,00	11	1.000
8017335280	ES 6,0/12	10	12	6,00	9	500
8017335290	ES 10,0/15	12	15	10,00	7	200
8017335300	ES 16,0/15	12	15	16,00	5	200
8017335310	ES 25,0/16	16	16	25,00	4	100
8017335320	ES 35,0/16	16	16	35,00	2	100
8017335330	ES 50,0/20	20	20	50,00	1	50



Ledli Sinyal Lambaları - Ø22 mm

LED Indicators - Ø22 mm

Ürün Kodu Product Code	Ürün Adı Product Name	Nominal Gerilim Nominal Voltage (V)	Renk Color	Amb. Mik. Pack. Qty (Adet/Pcs.)	
8026078912	SIL22-220 Kırmızı Sinyal Lambası Ledli	SIL22-220 Red Signal Lamp with LED	220V AC	●	25
8026078915	SIL22-220 Yeşil Sinyal Lambası Ledli	SIL22-220 Green Signal Lamp with LED	220V AC	●	25
8026078914	SIL22-220 Sarı Sinyal Lambası Ledli	SIL22-220 Yellow Signal Lamp with LED	220V AC	●	25
8026078916	SIL22-220 Mavi Sinyal Lambası Ledli	SIL22-220 Blue Signal Lamp with LED	220V AC	●	25
8026078919	SIL22-220 Beyaz Sinyal Lambası Ledli	SIL22-220 White Signal Lamp with LED	220V AC	○	25
8026078922	SIL22-220DC Kırmızı Sinyal Lambası Ledli	SIL22-220DC Red Signal Lamp with LED	220V DC	●	25
8026078925	SIL22-220DC Yeşil Sinyal Lambası Ledli	SIL22-220DC Green Signal Lamp with LED	220V DC	●	25
8026078924	SIL22-220DC Sarı Sinyal Lambası Ledli	SIL22-220DC Yellow Signal Lamp with LED	220V DC	●	25
8026078926	SIL22-220DC Mavi Sinyal Lambası Ledli	SIL22-220DC Blue Signal Lamp with LED	220V DC	●	25
8026078929	SIL22-220DC Beyaz Sinyal Lambası Ledli	SIL22-220DC White Signal Lamp with LED	220V DC	○	25
8026078932	SIL22-110 Kırmızı Sinyal Lambası Ledli	SIL22-110 Red Signal Lamp with LED	110V AC/DC	●	25
8026078935	SIL22-110 Yeşil Sinyal Lambası Ledli	SIL22-110 Green Signal Lamp with LED	110V AC/DC	●	25
8026078934	SIL22-110 Sarı Sinyal Lambası Ledli	SIL22-110 Yellow Signal Lamp with LED	110V AC/DC	●	25
8026078936	SIL22-110 Mavi Sinyal Lambası Ledli	SIL22-110 Blue Signal Lamp with LED	110V AC/DC	●	25
8026078939	SIL22-110 Beyaz Sinyal Lambası Ledli	SIL22-110 White Signal Lamp with LED	110V AC/DC	○	25
8026078942	SIL22-24 Kırmızı Sinyal Lambası Ledli	SIL22-24 Red Signal Lamp with LED	24V AC/DC	●	25
8026078945	SIL22-24 Yeşil Sinyal Lambası Ledli	SIL22-24 Green Signal Lamp with LED	24V AC/DC	●	25
8026078944	SIL22-24 Sarı Sinyal Lambası Ledli	SIL22-24 Yellow Signal Lamp with LED	24V AC/DC	●	25
8026078946	SIL22-24 Mavi Sinyal Lambası Ledli	SIL22-24 Blue Signal Lamp with LED	24V AC/DC	●	25
8026078949	SIL22-24 Beyaz Sinyal Lambası Ledli	SIL22-24 White Signal Lamp with LED	24V AC/DC	○	25



SIL22-24 Kırmızı/Red



SIL22-220 Yeşil/Green



SIL22-220 Sarı/Yellow



SIL22-220 Mavi/Blue



SIL22-24 Beyaz/White

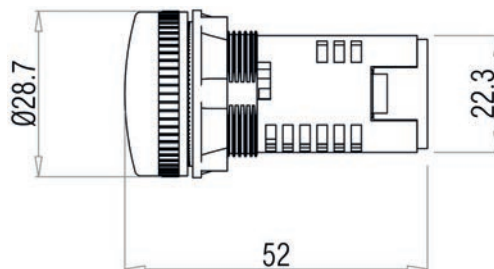

Yaylı Kumanda Butonları - Ø22 mm

Push Buttons Spring Return - Ø22 mm



Ürün Kodu Product Code	Ürün Adı Product Name	Kontakt Contact	Renk Color	Amb. Mik. Pack. Qty (Adet/Pcs.)
8025078002	PSR-1C Kırmızı Düz Yaylı Tip 1 NK	1 NK	Red	15
8025078075	PSR-1O Yeşil Düz Yaylı Tip 1 NA	1 NA	Green	15
8025078104	PSR-1O Sarı Düz Yaylı Tip 1 NA	1 NA	Yellow	15
8025078106	PSR-1O Mavi Düz Yaylı Tip 1 NA	1 NA	Blue	15
8025078109	PSR-1O Beyaz Düz Yaylı Tip 1 NA	1 NA	White	15
8025078100	PSR-1O Siyah Düz Yaylı Tip 1 NA	1 NA	Black	15

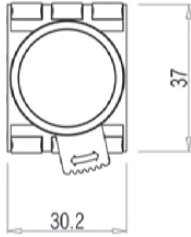
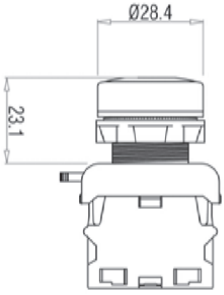

PSR-1O Sarı/Yellow



PSR-1C Kırmızı/Red



PSR-1C Yeşil/Green

Yaylı Kumanda Butonları - Ø22 mm - Kromajlı Seri

Push Buttons Spring Return Chromated - Ø22 mm

Ürün Kodu Product Code	Ürün Adı Product Name	Kontakt Contact	Renk Color	Amb. Mik. Pack. Qty (Adet/Pcs.)
8025078062	PSRC-1C Kırmızı Düz Yaylı Tip 1 NK Kromajlı	1 NK	Red	15
8025078105	PSRC-1O Yeşil Düz Yaylı Tip 1 NA Kromajlı	1 NA	Green	15
8025078114	PSRC-1O Sarı Düz Yaylı Tip 1 NA Kromajlı	1 NA	Yellow	15
8025078116	PSRC-1O Mavi Düz Yaylı Tip 1 NA Kromajlı	1 NA	Blue	15
8025078119	PSRC-1O Beyaz Düz Yaylı Tip 1 NA Kromajlı	1 NA	White	15
8025078110	PSRC-1O Siyah Düz Yaylı Tip 1 NA Kromajlı	1 NA	Black	15

LED'li Yaylı Kumanda Butonları - Ø 22 mm

Push Buttons Spring Return LED - Ø 22 mm



Ürün Kodu Product Code	Ürün Adı Product Name	Nominal Gerilim (V) Nominal Voltage (V)	Renk Color	Amb. Mik. Pack. Qty (Adet/Pcs.)
8025078022	PSRL-1C 220 Kırmızı Düz Yaylı Tip 1 NK Ledli	220 V AC/DC	Red	15
8025078085	PSRL-1O 220 Yeşil Düz Yaylı Tip 1 NA Ledli	220 V AC/DC	Green	15
8025078224	PSRL-1O 220 Sarı Düz Yaylı Tip 1 NA Ledli	220 V AC/DC	Yellow	15
8025078226	PSRL-1O 220 Mavi Düz Yaylı Tip 1 NA Ledli	220 V AC/DC	Blue	15
8025078229	PSRL-1O 220 Beyaz Düz Yaylı Tip 1 NA Ledli	220 V AC/DC	White	15
8025078032	PSRL-1C 110 Kırmızı Düz Yaylı Tip 1 NK Ledli	110 V AC/DC	Red	15
8025078095	PSRL-1O 110 Yeşil Düz Yaylı Tip 1 NA Ledli	110 V AC/DC	Green	15
8025078234	PSRL-1O 110 Sarı Düz Yaylı Tip 1 NA Ledli	110 V AC/DC	Yellow	15
8025078236	PSRL-1O 110 Mavi Düz Yaylı Tip 1 NA Ledli	110 V AC/DC	Blue	15
8025078239	PSRL-1O 110 Beyaz Düz Yaylı Tip 1 NA Ledli	110 V AC/DC	White	15
8025078042	PSRL-1C 48 Kırmızı Düz Yaylı Tip 1 NK Ledli	48 V AC/DC	Red	15
8025078205	PSRL-1O 48 Yeşil Düz Yaylı Tip 1 NA Ledli	48 V AC/DC	Green	15
8025078204	PSRL-1O 48 Sarı Düz Yaylı Tip 1 NA Ledli	48 V AC/DC	Yellow	15
8025078206	PSRL-1O 48 Mavi Düz Yaylı Tip 1 NA Ledli	48 V AC/DC	Blue	15
8025078209	PSRL-1O 48 Beyaz Düz Yaylı Tip 1 NA Ledli	48 V AC/DC	White	15
8025078052	PSRL-1C 24 Kırmızı Düz Yaylı Tip 1 NK Ledli	24 V AC/DC	Red	15
8025078215	PSRL-1O 24 Yeşil Düz Yaylı Tip 1 NA Ledli	24 V AC/DC	Green	15
8025078214	PSRL-1O 24 Sarı Düz Yaylı Tip 1 NA Ledli	24 V AC/DC	Yellow	15
8025078216	PSRL-1O 24 Mavi Düz Yaylı Tip 1 NA Ledli	24 V AC/DC	Blue	15
8025078219	PSRL-1O 24 Beyaz Düz Yaylı Tip 1 NA Ledli	24 V AC/DC	White	15

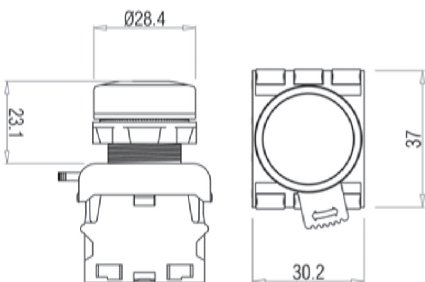

PSRL-1C Kırmızı/Red



PSRL-1O Yeşil/Green



PSRL-1O Mavi/Blue

Ürün Kodu Product Code	Ürün Adı Product Name	Nominal Gerilim (V) Nominal Voltage (V)	Renk Color	Amb. Mik. Pack. Qty (Adet/Pcs.)
8025078022	PSRL-1C 220 Kırmızı Düz Yaylı Tip 1 NK Ledli	220 V AC/DC	Red	15
8025078085	PSRL-1O 220 Yeşil Düz Yaylı Tip 1 NA Ledli	220 V AC/DC	Green	15
8025078224	PSRL-1O 220 Sarı Düz Yaylı Tip 1 NA Ledli	220 V AC/DC	Yellow	15
8025078226	PSRL-1O 220 Mavi Düz Yaylı Tip 1 NA Ledli	220 V AC/DC	Blue	15
8025078229	PSRL-1O 220 Beyaz Düz Yaylı Tip 1 NA Ledli	220 V AC/DC	White	15
8025078032	PSRL-1C 110 Kırmızı Düz Yaylı Tip 1 NK Ledli	110 V AC/DC	Red	15
8025078095	PSRL-1O 110 Yeşil Düz Yaylı Tip 1 NA Ledli	110 V AC/DC	Green	15
8025078234	PSRL-1O 110 Sarı Düz Yaylı Tip 1 NA Ledli	110 V AC/DC	Yellow	15
8025078236	PSRL-1O 110 Mavi Düz Yaylı Tip 1 NA Ledli	110 V AC/DC	Blue	15
8025078239	PSRL-1O 110 Beyaz Düz Yaylı Tip 1 NA Ledli	110 V AC/DC	White	15
8025078042	PSRL-1C 48 Kırmızı Düz Yaylı Tip 1 NK Ledli	48 V AC/DC	Red	15
8025078205	PSRL-1O 48 Yeşil Düz Yaylı Tip 1 NA Ledli	48 V AC/DC	Green	15
8025078204	PSRL-1O 48 Sarı Düz Yaylı Tip 1 NA Ledli	48 V AC/DC	Yellow	15
8025078206	PSRL-1O 48 Mavi Düz Yaylı Tip 1 NA Ledli	48 V AC/DC	Blue	15
8025078209	PSRL-1O 48 Beyaz Düz Yaylı Tip 1 NA Ledli	48 V AC/DC	White	15
8025078052	PSRL-1C 24 Kırmızı Düz Yaylı Tip 1 NK Ledli	24 V AC/DC	Red	15
8025078215	PSRL-1O 24 Yeşil Düz Yaylı Tip 1 NA Ledli	24 V AC/DC	Green	15
8025078214	PSRL-1O 24 Sarı Düz Yaylı Tip 1 NA Ledli	24 V AC/DC	Yellow	15
8025078216	PSRL-1O 24 Mavi Düz Yaylı Tip 1 NA Ledli	24 V AC/DC	Blue	15
8025078219	PSRL-1O 24 Beyaz Düz Yaylı Tip 1 NA Ledli	24 V AC/DC	White	15

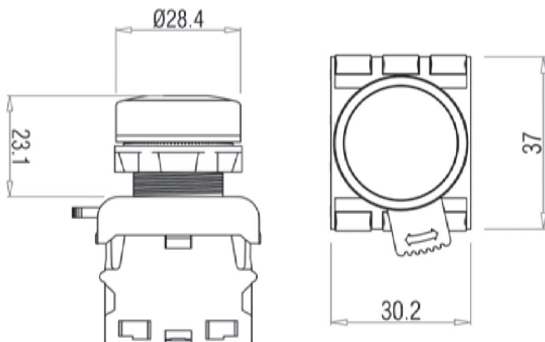

PSRLC-1C Kırmızı/Red



PSRLC-1O Yeşil/Green

Ürün Kodu Product Code	Ürün Adı Product Name	Kontakt Contact	Renk Color	Amb. Mik. Pack. Qty (Adet/Pcs.)
8025078302	DSR-1C10 Çiftli Yaylı Tip 1NA+1NK	DSR-1C10 Double Spring Return 1NO+1NC	1 NA + 1 NK	10
8025078700	DSRC-1C10 Çiftli Yaylı Tip 1NA+1NK Kromajlı	DSRC-1C10 Double Spring Return 1NO+1NC Chromated	1 NA + 1 NK	10
8025078312	DSRL-1C10 220 Çiftli Yaylı Tip 1NA+1NK Ledli	DSRL-1C10 220 Double Spring Return 1NO+1NC with LED	1 NA + 1 NK	10
8025078362	DSRL-1C10 110 Çiftli Yaylı Tip 1NA+1NK Ledli	DSRL-1C10 110 Double Spring Return 1NO+1NC with LED	1 NA + 1 NK	10
8025078372	DSRL-1C10 24 Çiftli Yaylı Tip 1NA+1NK Ledli	DSRL-1C10 24 Double Spring Return 1NO+1NC with LED	1 NA + 1 NK	10
8025079002	DSR-20 Ciftli yayli Tip 2NA	DSR-20 Double Spring Return 2NO	2 NA	10
8025079702	DSRC-20 Ciftli yayli Tip 2NA Kromajlı	DSR-20 Double Spring Return 2NO Chromated	2 NA	10
8025079012	DSRL-20 220 Ciftli yayli Tip 2NA Ledli	DSRL-20 220 Double Spring Return 2NO with LED	2 NA	10
8025079062	DSRL-20 110 Ciftli yayli Tip 2NA Ledli	DSRL-20 110 Double Spring Return 2NO with LED	2 NA	10
8025079072	DSRL-20 24 Ciftli yayli Tip 2NA Ledli	DSRL-20 24 Double Spring Return 2NO with LED	2 NA	10

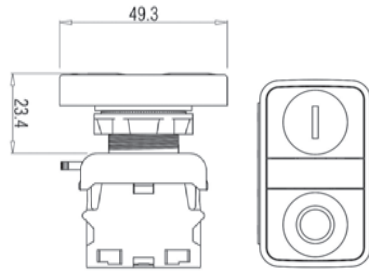

DSR-1C10

Kalıcı Tip Seçici Butonlar - Ø 22 mm

Selector Switches Maintained - Ø22 mm



Ürün Kodu Product Code	Ürün Adı Product Name	Kontakt Contac	Renk Color	Pozisyon Position	Amb. Mik. Pack. Qty (Adet/Pcs.)
8025078500	SSP-10 Kalıcı 0-1 Seçici Buton SSP-10, 2 pos. 1NO 90°	1 NA	●	0 1 V	12
8025078501	SSP-1C10 Kalıcı 1-0-2 Seçici Buton SSP-1C10, 3 pos. 1NO +1NC	1 NA + 1NK	●	1 0 2 V	12
8025078510	SSP-20 Kalıcı 1-0-2 Seçici Buton SSP-20, 3 pos. 2NO 60°	2 NA	●	1 0 2 V	12
8025078710	SSPC-10 Kalıcı 0-1 Seçici Buton - Kromajlı SSPC-10, 2 pos. 1NO 90° Chromated	1 NA	●	0 1 V	12
8025078720	SSPC-20 Kalıcı 1-0-2 Seçici Buton - Kromajlı SSPC-20, 3 pos. 2NO 60° Chromated	2 NA	●	1 0 2 V	12

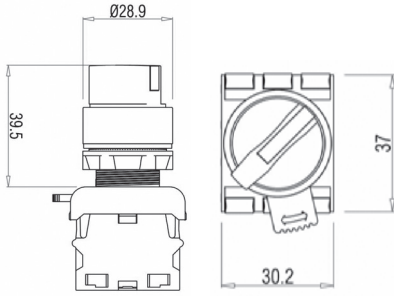

SSPC-20



SSP-20

Acil Stop Kumanda Butonları - Ø 22 mm

Emergency Stop - Ø 22 mm



Ürün Kodu Product Code	Ürün Adı Product Name	Kontakt Contact	Renk Color	Amb. Mik. Pack. Qty (Adet/Pcs.)
8025078012	EPB-1C Acil Stop 1 NK EPB-1C Emergency Stop 1 NC	1NK	●	10

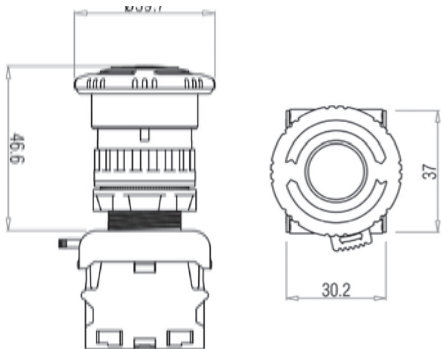

EPB-1C

LED'li Kalıcı Tip Seçici Butonlar - Ø 22 mm

Selector Switches Maintained with LED - Ø22 mm



Ürün Kodu Product Code	Ürün Adı Product Name	Nominal Gerilim (V) Nominal Voltage (V)	Renk Color	Pozisyon Position	Amb. Mik. Pack. Qty (Adet/Pcs.)
8025078602	SSP-10 220 L Kırmızı Kalıcı Işıklı 0-1 Seçici Buton	220 V AC/DC	Red	0 1	12
8025078605	SSP-10 220 L Yeşil Kalıcı Işıklı 0-1 Seçici Buton	220 V AC/DC	Green	0 1	12
8025078604	SSP-10 220 L Sarı Kalıcı Işıklı 0-1 Seçici Buton	220 V AC/DC	Yellow	0 1	12
8025078622	SSP-20 220 L Kırmızı Kalıcı Işıklı 1-0-2 Seçici Buton	220 V AC/DC	Red	1 0 2	12
8025078615	SSP-20 220 L Yeşil Kalıcı Işıklı 1-0-2 Seçici Buton	220 V AC/DC	Green	1 0 2	12
8025078614	SSP-20 220 L Sarı Kalıcı Işıklı 1-0-2 Seçici Buton	220 V AC/DC	Yellow	1 0 2	12

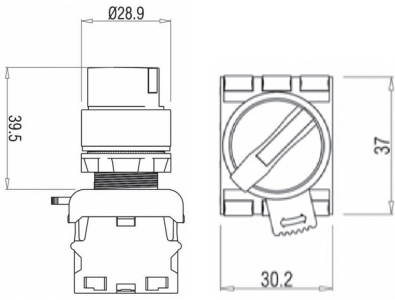

SSP-10 220 L Yeşil/Green



SSP-10 220 L Kırmızı/Red

LED'li Tip Yay Dönüslü Seçici Butonlar - Ø 22 mm

Selector Switch Momentary with LED - Ø22 mm



Ürün Kodu Product Code	Ürün Adı Product Name	Nominal Gerilim (V) Nominal Voltage (V)	Renk Color	Pozisyon Position	Amb. Mik. Pack. Qty (Adet/Pcs.)
8025078402	SSM-10 220 L Kırmızı Yay Dönüslü Işıklı 0-1 Seçici Buton	220 V AC/DC	Red	0 1	12
8025078405	SSM-10 220 L Yeşil Yay Dönüslü Işıklı 0-1 Seçici Buton	220 V AC/DC	Green	0 1	12
8025078404	SSM-10 220 L Sarı Yay Dönüslü Işıklı 0-1 Seçici Buton	220 V AC/DC	Yellow	0 1	12
8025078422	SSM-20 220 L Kırmızı Yay Dönüslü Işıklı 1-0-2 Seçici Buton	220 V AC/DC	Red	1 0 2	12
8025078415	SSM-20 220 L Yeşil Yay Dönüslü Işıklı 1-0-2 Seçici Buton	220 V AC/DC	Green	1 0 2	12
8025078424	SSM-20 220 L Sarı Yay Dönüslü Işıklı 1-0-2 Seçici Buton	220 V AC/DC	Yellow	1 0 2	12

LED li Kalıcı ve Yaylı Tip Seçici Butonların 110V AC/DC ve 24V AC/DC Nominal Gerilimleri için lütfen satış temsilcinizle irtibata geçiniz.

Yay Dönüflü Seçi Butonlar - Ø 22 mm

Selector Switch Momentary - Ø22 mm



Ürün Kodu Product Code	Ürün Adı Product Name	Kontakt Contact	Renk Color	Pozisyon Position	Amb. Mik. Pack. Qty (Adet/Pcs.)
8025078320	SSM-10 Yay Dönüflü 0-1 Seçi Buton	1 NA	●		12
8025078330	SSM-20 Yay Dönüflü 1-0-2 Seçi Buton	2 NA	●		12
8025078340	SSMC-10 Yay Dönüflü 0-1 Seçi Buton - Kromajlı	1 NA	●		12
8025078350	SSMC-20 Yay Dönüflü 1-0-2 Seçi Buton - Kromajlı	2 NA	●		12

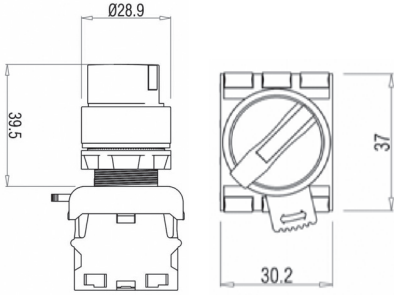

SMM-10

Kontak Blok Tipleri

Contact Block Types



Ürün Kodu Product Code	Ürün Adı Product Name	Kontak Contact	Amb. Mik. Pack. Qty (Adet/Pcs.)
8025078800	CNT-O NA Kontak	CNT-O NO Contact	50
8025078810	CNT-C NK Kontak	CNT-C NC Contact	50
8025078820	CNT-S Işık Kontak Blok	CNT-S Signal Contact	50

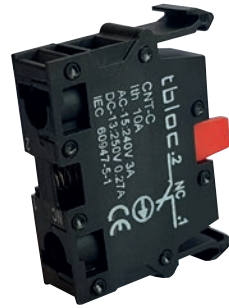
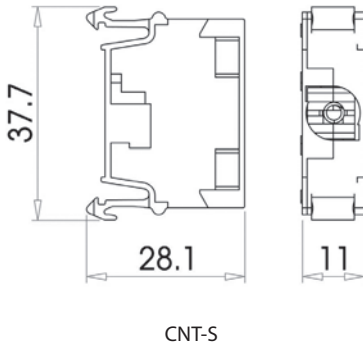
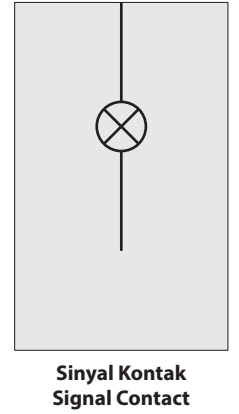
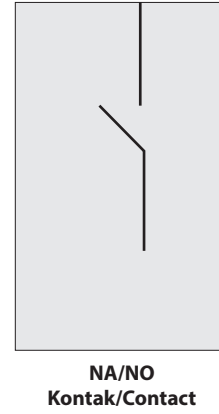
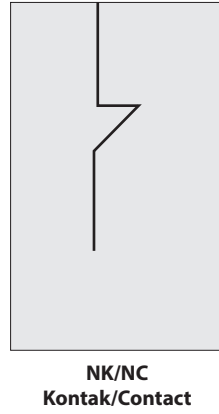
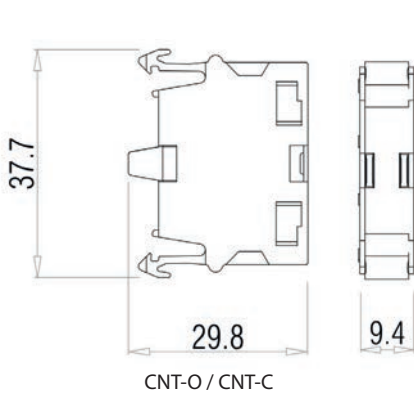

Teknik Bilgiler / Technical Information

Standart / Standard	IEC 60947-5-1
Çalışma Sıcaklığı min/maks. / Operating Temperature min/max (°C)	-5 / +40
Kirlilik Derecesi / Pollution Severity	3
Yalıtım Gerilimi / Rated Insulation Voltage (V)	400
Darbe Beyan Gerilimi / Rated Impulse Withstand Voltage (kV)	4
Klasik Açık hava Termal Akım / Conventional Thermal Current (A)	10
Kullanım Sınıfı / Utilization Category	AC 15
Nominal Çalışma Gerilimi / Rated Operational Voltage (V)	Nominal Çalışma Akımı / Rated Operational Current (A)
380	1,9
240	3
120	6

Termal İndikatör Kılıflar ve Pullar

Thermal Indicator Covers and Washers



- **47.9 kV izolasyon**

ısıyla daralan makaronlara göre yüksek izolasyon sağlarken aşırı ısınma indikatörü olarak da yardımcıdır

- **Kolay Montaj**

kablo kesmeden de bakım ve değişim yapabilirsiniz

- **Önleyici bakım ve koruma**

iki sıcaklık kontrol işlemi arasında yaşanmış olan aşırı ısınmayı tespit ederek sisteminizi korursunuz

- **Isıya duyarlı renk değişimi**

ile termal kameraya gerek kalmadan çıplak gözle aşırı ısınmayı tespit edebilirsiniz

- **Farklı renk seçenekleri**

faz kodlamanıza yardımcıdır

Termal İndikatör Kılıflar ve Pullar

Thermal Indicator Covers and Washers



- **47.9 kV isolation**
will ensure a higher isolation compared with heat shrinkable tubes in addition to its over heat indication function
- **Easy installation**
you can perform your maintenance and replacements without any cable cut
- **Predictive maintenance and protection**
you can detect the over heating problems between two different temperature controls and protect your system
- **Heat sensitive color change**
will eliminate your heat gun requirement, and you can detect the over heat by naked eye
- **Different color options**
will assist your phase identification

Termal İndikatör Kılıflar

Thermal Indicator Covers

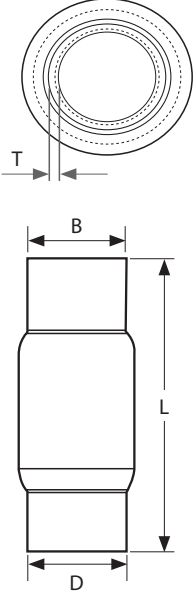

Ürün Kodu Product Code	Ürün Adı Product Name	Ölçüler / Dimensions				Kesit Cross Sect. (mm ²)	AWG	Amb. Mik. Pack. Qty (Adet/pcs.)
		D	B	L	T			
8028320020	TIK 10 Siyah / Black	7,10	6,50	21,00	1,10	10	8	12
8028320030	TIK 16 Siyah / Black	9,00	7,70	24,00	1,14	16	6	12
8028320040	TIK 25 Siyah / Black	10,25	10,20	31,21	1,25	25	4	12
8028320050	TIK 35 Siyah / Black	10,71	10,70	35,00	1,30	35	2-3	12
8028320060	TIK 50 Siyah / Black	11,60	12,80	37,70	1,50	50	1	12
8028320070	TIK 70 Siyah / Black	14,60	14,00	39,00	1,60	70	1/0	12
8028320080	TIK 95 Siyah / Black	16,60	16,10	43,50	1,64	95	2/0	6
8028320090	TIK 120 Siyah / Black	21,60	19,70	48,50	1,75	120	3/0	6
8028320100	TIK 150 Siyah / Black	23,40	20,60	56,65	1,85	150	4/0	6
8028320110	TIK 185 Siyah / Black	25,93	24,40	64,00	1,90	185	250-300 kcmil	3
8028320120	TIK 240 Siyah / Black	30,13	26,80	70,00	2,00	240	350-400 kcmil	3
8028320130	TIK 300 Siyah / Black	35,19	30,70	76,00	2,16	300	450-500 kcmil	3
8028320300	TIK 400 Siyah / Black	35,00	35,00	101,00	2,10	400	550 - 650 kcmil	1
8028320310	TIK 500 Siyah / Black	39,50	38,12	107,00	2,40	500	700 - 800 kcmil	1

Geri Bildirim Referans Noktası
Reference Point Feedback

Renk Kodları / Color Codes (All Product)



TIK 70
8028320070



TIK 70
802832002

Siyah / Black	0
Kırmızı / Red	2
Sarı / Yellow	4
Yeşil / Green	5
Mavi / Blue	6



Termal İndikatör Pullar

Thermal Indicator Washers

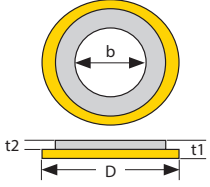

Ürün Kodu Product Code	Ürün Adı Product Name	Ölçüler / Dimensions				Amb. Mik. Pack. Qty (Adet/pcs.)
		D	b	t1	t2	
8028320400	TIW M8 Siyah / Black	17	8,2	3	1,5	5
8028320410	TIW M10 Siyah / Black	23	10,2	3	1,5	5
8028320420	TIW M12 Siyah / Black	26	12,2	3	1,5	5
8028320430	TIW M14 Siyah / Black	32	14,2	3	1,5	5
8028320440	TIW M16 Siyah / Black	32	16,2	3	1,5	5

Renk Kodları / Color Codes (All Product)		
Siyah / Black	0
Kırmızı / Red	2
Sarı / Yellow	4
Yeşil / Green	5
Mavi / Blue	6





MERKEZ / HEADQUARTER

**Tbloc Elektrik Elektronik
Sanayi ve Ticaret A.Ş.**

29 Ekim Mahallesi
10001 Sokak No: 50/4
35663 Menemen İzmir Turkey

Tel: +90 232 833 26 96
Fax: +90 232 833 26 97

info@tbloc.com.tr
www.tbloc.com.tr

